

# UNLIMITED SUPPLIES INC

2320 LOUISIANA AVE N  
GOLDEN VALLEY, MN 55427

**PHONE 763-746-5150**  
800-943-2009

FAX 763-746-5151

[UNLIMITED-USA.COM](http://UNLIMITED-USA.COM)

THE FULL SERVICE SUPPLIER

LET OUR INVENTORY MANAGEMENT SPECIALISTS

ORGANIZE YOUR STOCK

PROVIDE BINS & LABELS

CREATE CUSTOM ASSORTMENTS

MONITOR INVENTORY LEVELS

USE BAR CODE ORDER ENTRY

IMMEDIATELY DELIVER RUSH ORDERS

# BOLTS & PINS

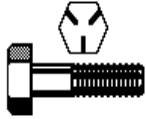

GRADE 5 HEX CAP SCREWS  
PAGES 1-4

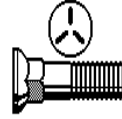

PLOW BOLTS GRADE 5  
PAGE 34

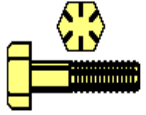

GRADE 8 HEX CAP SCREWS  
PAGES 5-8

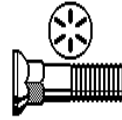

PLOW BOLTS GRADE 8  
PAGE 34-35



GRADE 9 HEX CAP SCREWS  
PAGES 18-20

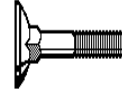

ELEVATOR BOLTS  
PAGE 33

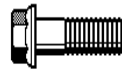

FLANGE BOLTS GRADE 8  
PAGE 33



STEP BOLTS  
PAGE 33

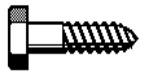

HEX LAG BOLTS  
PAGE 36



CARRIAGE BOLTS GRADE 2 ZINC  
PLATED  
PAGES 30-31

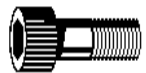

SOCKET HEAD CAP  
SCREWS  
PAGES 45-48



CARRIAGE BOLTS GRADE 5  
PAGE 32



HANGER BOLTS  
PAGE 33



SHAKER SCREEN BOLTS GR 8  
PAGE 32

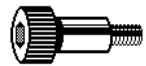

SHOULDER BOLTS  
PAGE 53-54



COTTER PINS  
PAGE 55

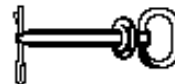

HITCH PINS  
PAGE 58



BRIDGE PINS  
(HAIRPIN COTTERS)  
PAGE 58

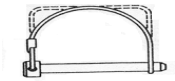

SNAPPER PINS  
PAGE 58



UNIVERSAL CLEVIS PINS  
PAGE 57



CLEVIS PINS  
PAGE 56



LYNCH PINS  
PAGE 58



TAPER PINS  
PAGE 59

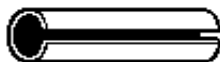

SPRING ROLL PINS  
PAGE 60-61

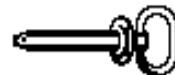

COTTERLESS  
HITCH PINS  
PAGE 59

# SCREWS



SOCKET HEAD CAP SCREWS  
(LOW HEAD)  
PAGE 49



SOCKET HEAD CAP SCREWS (FLAT  
HEAD)  
PAGE 49-50



SOCKET HEAD CAP SCREWS (   
BUTTON HEAD)  
PAGE 50

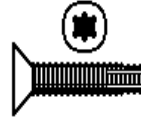

TORX DRIVE FLAT HEAD TYPE "F"  
FLOOR BOARD SCREWS  
PAGE 44



UNSLOTTED HEX TEK SCREWS  
PAGE 44

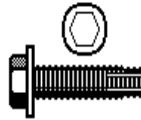

UNSLOTTED HEX SCREWS  
TYPE "F"  
PAGE 44

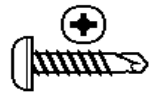

PHILLIPS PAN TEK SCREWS  
PAGE 44



SPADE LAG SCREWS  
PAGE 35



DOWEL SCREWS  
PAGE 35

SOCKET SET SCREWS CUP POINT  
(CONE, FULL DOG, HALF DOG & OVAL POINTS ALSO  
AVAILABLE)  
PAGES 51-52



CUP POINT



CONE

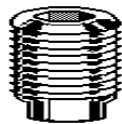

FULL DOG

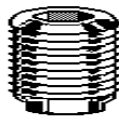

HALF DOG

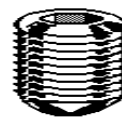

OVAL

# NUTS & WASHERS



USS GRADE 5 HEX NUTS  
PAGE 21



ACORN NUTS  
PAGE 25



FLEXLOC NUTS  
PAGE 25



SAE GR 5 HEX NUTS  
PAGE 21

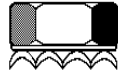

HEX KEYS LOCK NUTS  
PAGE 21



SAE SLOTTED HEX NUTS  
PAGE 23



USS GR 8 HEX NUTS  
PAGE 22

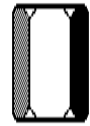

COUPLING NUTS  
PAGE 25



HIGH NUTS HEAT TREATED  
PAGE 23



SAE GR 8 HEX NUTS  
PAGE 22



T-NUTS 3 PRONG  
PAGE 25



WING NUTS  
PAGE 24



USS & SAE GR 9 HEX  
NUTS PAGE 22



USS CASTLE HEX NUTS  
PAGE 23



HEX JAM NUTS  
PAGE 23



USS GR 5 & 8 NYLOC NUTS  
PAGE 22



HEX FLANGE LOCK NUTS  
PAGE 24



HEAVY HEX NUTS  
GRADE 2H  
PAGE 23



USS & SAE GR 8 NYLOC  
NUTS  
PAGE 22



SERRATED FLANGE NUTS  
PAGE 24



HEX FLANGE NUTS GR 8  
PAGE 24



USS & SAE GR 8 ALL METAL  
LOCK NUTS  
PAGE 22



USS GR 2 FLAT WASHERS  
PAGE 26



SAE GR 2 FLAT WASHERS  
PAGE 28



EXTRA THICK GR 8 FLAT  
WASHERS  
PAGE 26



NARROW & WIDE RIM  
MACHINERY BUSHINGS  
PAGE 27



SAE GR 8 FLAT WASHERS  
PAGE 28



USS GR 8 FLAT WASHERS  
PAGE 26



STANDARD LOCK WASHERS  
PAGE 28



FENDER WASHERS  
1/8" THICK  
PAGE 26



COUNTERSUNK  
FINISHING WASHERS  
PAGE 26



GRADE 8 ALLOY LOCK  
WASHERS  
PAGE 28



HIGH COLLAR  
LOCK WASHERS  
PAGE 28



COUNTERSUNK  
LOCK WASHERS  
PAGE 29



EXTERNAL  
LOCK WASHERS  
PAGE 29



INTERNAL  
LOCK WASHERS  
PAGE 29



EXTERNAL-INTERNAL  
LOCK WASHERS  
PAGE 29

UNLIMITED SUPPLIES

## MACHINE SCREW PAGES 37-40

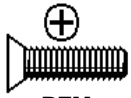

PFM  
PHILLIPS FLAT

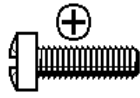

PLM  
PHILLIPS FILLISTER



POM  
PHILLIPS OVAL

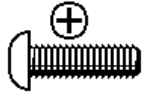

PRM  
PHILLIPS ROUND

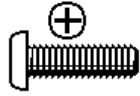

PPM  
PHILLIPS PAN

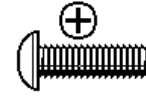

PTM  
PHILLIPS TRUSS



SFM  
SLOTTED FLAT

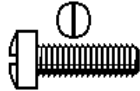

SLM  
SLOTTED FILLISTER

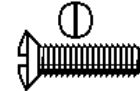

SOM  
SLOTTED OVAL

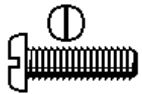

SPM  
SLOTTED PAN

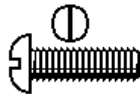

SRM  
SLOTTED ROUND



STM  
SLOTTED TRUSS

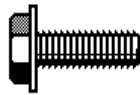

UHM  
UNSLOTTED HEX

## TAPPING SCREWS PAGES 41-43



PFT  
PHILLIPS FLAT



POT  
PHILLIPS OVAL

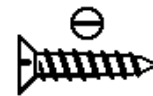

SFT  
SLOTTED FLAT



PPT  
PHILLIPS PAN

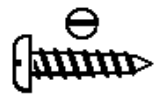

SPT  
SLOTTED PAN



SOT  
SLOTTED OVAL



PTT  
PHILLIPS TRUSS



SHT  
SLOTTED HEX



STT  
SLOTTED TRUSS

# METRIC FASTENERS

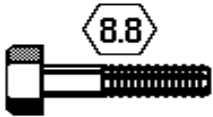

**METRIC HEX CAP SCREWS  
GRADE 8.8 & 10.9**

**PAGES 95-97**

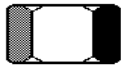

**HEX NUTS  
GRADE 8.8 & 10.9**



**NYLON INSERT  
LOCKNUTS  
GRADE 8.8 & 10.9**

**PAGE 97**

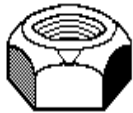

**LOCK NUTS  
GRADE 8.8 & 10.9**



**METRIC WASHERS  
GRADE 8.8 & 10.9**

**PAGE 98**



# CARBIDE BURRS

PAGES 93-94



CYLINDRICAL



CYLINDRICAL  
RADIUS END



FLAME



TREE POINTED  
END



CONE RADIUS  
END 14\* TAPER



BALL END



EGG

TREE RADIUS  
END

CONE POINTED  
END

60\* TAPER

# ELECTRICAL TERMINALS

HEAT SHRINK, NYLON INSULATED AND NON-INSULATED  
PAGES 90-92

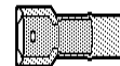
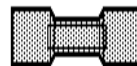
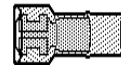
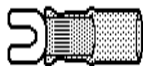

UNLIMITED SUPPLIES

# O-RINGS & OTHER INDUSTRIAL SUPPLIES

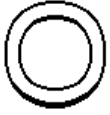

O-RINGS, QUAD RINGS  
TEFLON BACK-UP WASHERS &  
VITON O-RINGS



PAGES 63-64



KEYSTOCK &  
WOODRUFF KEYS



PAGE 62



THREADED ROD

PAGE 87

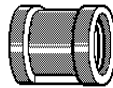

PIPE FITTINGS

PAGES 86-87



# BRASS VALVES & FITTINGS

**AIR BRAKE HOSE**



PAGE 84

**BRASS PIPE FITTINGS**



PAGES 81-82

**CAPTIVE SLEEVE COMP FITTINGS**

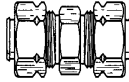

PAGES 78-79

**COMPRESSION FITTINGS**

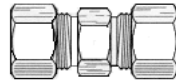

PAGES 79-80

**COPPER AIR BRAKE FITTINGS**

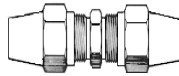

PAGES 72-74

**DOT PUSH-IN AIR BRAKE FITTINGS**

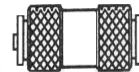

PAGE 76

**GREASE FITTINGS**



PAGE 85

**INVERTED FLARE FITTINGS**

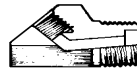

PAGES 71-72

**NTA AIR BRAKE FITTINGS**

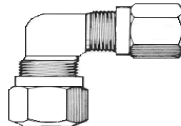

PAGES 74-75

**RUBBER AIR BRAKE FITTINGS**

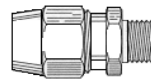

PAGE 77

**STAYPUT HOSE BARB FITTINGS**

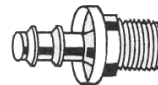

PAGES 83-84

**SAE 45 DEGREE FITTINGS**

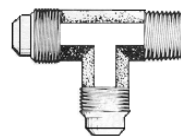

PAGES 68-70

**VALVES**

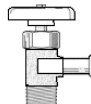

PAGE 85

UNLIMITED SUPPLIES

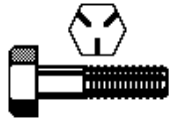

**HEX CAP SCREWS GR-5  
DOMESTIC - ZINC PLATED  
TENSILE STRENGTH 120,000 PSI**

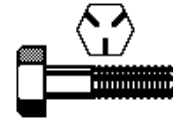

Size	Pkg Qty	UNC 1/4-20	UNF 1/4-28
1/4 X 1/2	100	25C50HH5	25F50HH5
1/4 X 5/8	100	25C62HH5	25F62HH5
1/4 X 3/4	100	25C75HH5	25F75HH5
1/4 X 7/8	100	25C87HH5	25F87HH5
1/4 X 1	100	25C100HH5	25F100HH5
1/4 X 1 1/4	100	25C125HH5	25F125HH5
1/4 X 1 1/2	100	25C150HH5	25F150HH5
1/4 X 1 3/4	100	25C175HH5	25F175HH5
1/4 X 2	100	25C200HH5	25F200HH5
1/4 X 2 1/4	50	25C225HH5	25F225HH5
1/4 X 2 1/2	50	25C250HH5	25F250HH5
1/4 X 2 3/4	50	25C275HH5	25F275HH5
1/4 X 3	50	25C300HH5	25F300HH5
1/4 X 3 1/4	50	25C325HH5	25F325HH5
1/4 X 3 1/2	50	25C350HH5	25F350HH5
1/4 X 3 3/4	50	25C375HH5	25F375HH5
1/4 X 4	50	25C400HH5	25F400HH5
1/4 X 4 1/2	50	25C450HH5	25F450HH5
1/4 X 5	50	25C500HH5	25F500HH5
1/4 X 5 1/2	50	25C550HH5	25F550HH5
1/4 X 6	50	25C600HH5	25F600HH5
1/4 X 6 1/2	25	25C650HH5	25F650HH5
1/4 X 7	25	25C700HH5	25F700HH5
1/4 X 7 1/2	25	25C750HH5	25F750HH5
1/4 X 8	25	25C800HH5	25F800HH5

Size	Pkg Qty	UNC 5/16-18	UNF 5/16-24
5/16 X 4	50	31C400HH5	31F400HH5
5/16 X 4 1/2	50	31C450HH5	31F450HH5
5/16 X 5	50	31C500HH5	31F500HH5
5/16 X 5 1/2	50	31C550HH5	31F550HH5
5/16 X 6	50	31C600HH5	31F600HH5
5/16 X 6 1/2	25	31C650HH5	31F650HH5
5/16 X 7	25	31C700HH5	31F700HH5
5/16 X 7 1/2	25	31C750HH5	31F750HH5
5/16 X 8	25	31C800HH5	31F800HH5

Size	Pkg Qty	UNC 3/8-16	UNF 3/8-24
3/8 X 1/2	100	37C50HH5	37F50HH5
3/8 X 5/8	100	37C62HH5	37F62HH5
3/8 X 3/4	100	37C75HH5	37F75HH5
3/8 X 7/8	100	37C87HH5	37F87HH5
3/8 X 1	100	37C100HH5	37F100HH5
3/8 X 1 1/4	100	37C125HH5	37F125HH5
3/8 X 1 1/2	100	37C150HH5	37F150HH5
3/8 X 1 3/4	50	37C175HH5	37F175HH5
3/8 X 2	50	37C200HH5	37F200HH5
3/8 X 2 1/4	50	37C225HH5	37F225HH5
3/8 X 2 1/2	50	37C250HH5	37F250HH5
3/8 X 2 3/4	50	37C275HH5	37F275HH5
3/8 X 3	50	37C300HH5	37F300HH5
3/8 X 3 1/4	25	37C325HH5	37F325HH5
3/8 X 3 1/2	25	37C350HH5	37F350HH5
3/8 X 3 3/4	25	37C375HH5	37F375HH5
3/8 X 4	25	37C400HH5	37F400HH5
3/8 X 4 1/4	25	37C425HH5	37F425HH5
3/8 X 4 1/2	25	37C450HH5	37F450HH5
3/8 X 4 3/4	25	37C475HH5	37F475HH5
3/8 X 5	25	37C500HH5	37F500HH5
3/8 X 5 1/2	25	37C550HH5	37F550HH5
3/8 X 6	25	37C600HH5	37F600HH5
3/8 X 6 1/2	25	37C650HH5	37F650HH5
3/8 X 7	25	37C700HH5	37F700HH5
3/8 X 7 1/2	25	37C750HH5	37F750HH5
3/8 X 8	25	37C800HH5	37F800HH5

Size	Pkg Qty	UNC 5/16-18	UNF 5/16-24
5/16 X 1/2	100	31C50HH5	31F50HH5
5/16 X 5/8	100	31C62HH5	31F62HH5
5/16 X 3/4	100	31C75HH5	31F75HH5
5/16 X 7/8	100	31C87HH5	31F87HH5
5/16 X 1	100	31C100HH5	31F100HH5
5/16 X 1 1/4	100	31C125HH5	31F125HH5
5/16 X 1 1/2	100	31C150HH5	31F150HH5
5/16 X 1 3/4	100	31C175HH5	31F175HH5
5/16 X 2	100	31C200HH5	31F200HH5
5/16 X 2 1/4	50	31C225HH5	31F225HH5
5/16 X 2 1/2	50	31C250HH5	31F250HH5
5/16 X 2 3/4	50	31C275HH5	31F275HH5
5/16 X 3	50	31C300HH5	31F300HH5
5/16 X 3 1/4	50	31C325HH5	31F325HH5
5/16 X 3 1/2	50	31C350HH5	31F350HH5
5/16 X 3 3/4	50	31C375HH5	31F375HH5

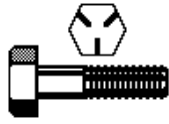

## HEX CAP SCREWS GR-5 DOMESTIC - ZINC PLATED TENSILE STRENGTH 120.000 PSI

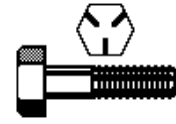

Size	Pkg Qty	UNC 7/16-14	UNF 7/16-20
7/16 X 3/4	50	43C75HH5	43F75HH5
7/16 X 7/8	50	43C87HH5	43F87HH5
7/16 X 1	50	43C100HH5	43F100HH5
7/16 X 1 1/4	50	43C125HH5	43F125HH5
7/16 X 1 1/2	50	43C150HH5	43F150HH5
7/16 X 1 3/4	50	43C175HH5	43F175HH5
7/16 X 2	50	43C200HH5	43F200HH5
7/16 X 2 1/4	25	43C225HH5	43F225HH5
7/16 X 2 1/2	25	43C250HH5	43F250HH5
7/16 X 2 3/4	25	43C275HH5	43F275HH5
7/16 X 3	25	43C300HH5	43F300HH5
7/16 X 3 1/4	25	43C325HH5	43F325HH5
7/16 X 3 1/2	25	43C350HH5	43F350HH5
7/16 X 3 3/4	25	43C375HH5	43F375HH5
7/16 X 4	25	43C400HH5	43F400HH5
7/16 X 4 1/2	25	43C450HH5	43F450HH5
7/16 X 5	25	43C500HH5	43F500HH5
7/16 X 5 1/2	25	43C550HH5	43F550HH5
7/16 X 6	25	43C600HH5	43F600HH5
7/16 X 6 1/2	25	43C650HH5	43F650HH5
7/16 X 7	25	43C700HH5	43F700HH5
7/16 X 7 1/2	25	43C750HH5	43F750HH5
7/16 X 8	25	43C800HH5	43F800HH5

Size	Pkg Qty	UNC 1/2-13	UNF 1/2-20
1/2 X 4 3/4	25	50C475HH5	50F475HH5
1/2 X 5	25	50C500HH5	50F500HH5
1/2 X 5 1/2	25	50C550HH5	50F550HH5
1/2 X 6	25	50C600HH5	50F600HH5
1/2 X 6 1/2	25	50C650HH5	50F650HH5
1/2 X 7	25	50C700HH5	50F700HH5
1/2 X 7 1/2	25	50C750HH5	50F750HH5
1/2 X 8	25	50C800HH5	50F800HH5

Size	Pkg Qty	UNC 9/16-12	UNF 9/16-18
9/16 X 1	25	56C100HH5	56F100HH5
9/16 X 1 1/4	25	56C125HH5	56F125HH5
9/16 X 1 1/2	25	56C150HH5	56F150HH5
9/16 X 1 3/4	25	56C175HH5	56F175HH5
9/16 X 2	25	56C200HH5	56F200HH5
9/16 X 2 1/4	25	56C225HH5	56F225HH5
9/16 X 2 1/2	25	56C250HH5	56F250HH5
9/16 X 2 3/4	25	56C275HH5	56F275HH5
9/16 X 3	25	56C300HH5	56F300HH5
9/16 X 3 1/4	25	56C325HH5	56F325HH5
9/16 X 3 1/2	25	56C350HH5	56F350HH5
9/16 X 3 3/4	25	56C375HH5	56F375HH5
9/16 X 4	25	56C400HH5	56F400HH5
9/16 X 4 1/2	25	56C450HH5	56F450HH5
9/16 X 5	25	56C500HH5	56F500HH5
9/16 X 5 1/2	25	56C550HH5	56F550HH5
9/16 X 6	25	56C600HH5	56F600HH5
9/16 X 6 1/2	25	56C650HH5	56F650HH5
9/16 X 7	25	56C700HH5	56F700HH5
9/16 X 7 1/2	25	56C750HH5	56F750HH5
9/16 X 8	25	56C800HH5	56F800HH5

Size	Pkg Qty	UNC 1/2-13	UNF 1/2-20
1/2 X 3/4	50	50C75HH5	50F75HH5
1/2 X 7/8	50	50C87HH5	50F87HH5
1/2 X 1	50	50C100HH5	50F100HH5
1/2 X 1 1/4	50	50C125HH5	50F125HH5
1/2 X 1 1/2	50	50C150HH5	50F150HH5
1/2 X 1 3/4	50	50C175HH5	50F175HH5
1/2 X 2	50	50C200HH5	50F200HH5
1/2 X 2 1/4	25	50C225HH5	50F225HH5
1/2 X 2 1/2	25	50C250HH5	50F250HH5
1/2 X 2 3/4	25	50C275HH5	50F275HH5
1/2 X 3	25	50C300HH5	50F300HH5
1/2 X 3 1/4	25	50C325HH5	50F325HH5
1/2 X 3 1/2	25	50C350HH5	50F350HH5
1/2 X 3 3/4	25	50C375HH5	50F375HH5
1/2 X 4	25	50C400HH5	50F400HH5
1/2 X 4 1/4	25	50C425HH5	50F425HH5
1/2 X 4 1/2	25	50C450HH5	50F450HH5

Size	Pkg Qty	UNC 5/8-11	UNF 5/8-18
5/8 X 1	25	62C100HH5	62F100HH5
5/8 X 1 1/4	25	62C125HH5	62F125HH5
5/8 X 1 1/2	25	62C150HH5	62F150HH5
5/8 X 1 3/4	25	62C175HH5	62F175HH5
5/8 X 2	25	62C200HH5	62F200HH5
5/8 X 2 1/4	25	62C225HH5	62F225HH5
5/8 X 2 1/2	25	62C250HH5	62F250HH5
5/8 X 2 3/4	25	62C275HH5	62F275HH5

UNLIMITED SUPPLIES

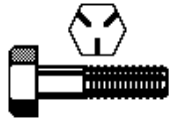

## HEX CAP SCREWS GR-5 DOMESTIC - ZINC PLATED TENSILE STRENGTH 120.000 PSI

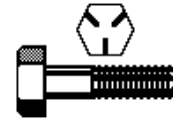

Size	Pkg Qty	UNC 5/8-11	UNF 5/8-18
5/8 X 3	25	62C300HH5	62F300HH5
5/8 X 3 1/4	25	62C325HH5	62F325HH5
5/8 X 3 1/2	25	62C350HH5	62F350HH5
5/8 X 3 3/4	25	62C375HH5	62F375HH5
5/8 X 4	25	62C400HH5	62F400HH5
5/8 X 4 1/2	25	62C450HH5	62F450HH5
5/8 X 5	25	62C500HH5	62F500HH5
5/8 X 5 1/2	25	62C550HH5	62F550HH5
5/8 X 6	25	62C600HH5	62F600HH5
5/8 X 6 1/2	25	62C650HH5	62F650HH5
5/8 X 7	25	62C700HH5	62F700HH5
5/8 X 7 1/2	25	62C750HH5	62F750HH5
5/8 X 8	25	62C800HH5	62F800HH5
5/8 X 8 1/2	10	62C850HH5	62F850HH5
5/8 X 9	10	62C900HH5	62F900HH5
5/8 X 9 1/2	10	62C950HH5	62F950HH5
5/8 X 10	10	62C1000HH5	62F1000HH5

Size	Pkg Qty	UNC 3/4-10	UNF 3/4-16
3/4 X 1	25	75C100HH5	75F100HH5
3/4 X 1 1/4	25	75C125HH5	75F125HH5
3/4 X 1 1/2	25	75C150HH5	75F150HH5
3/4 X 1 3/4	25	75C175HH5	75F175HH5
3/4 X 2	25	75C200HH5	75F200HH5
3/4 X 2 1/4	25	75C225HH5	75F225HH5
3/4 X 2 1/2	25	75C250HH5	75F250HH5
3/4 X 2 3/4	25	75C275HH5	75F275HH5
3/4 X 3	25	75C300HH5	75F300HH5
3/4 X 3 1/4	25	75C325HH5	75F325HH5
3/4 X 3 1/2	25	75C350HH5	75F350HH5
3/4 X 3 3/4	25	75C375HH5	75F375HH5
3/4 X 4	25	75C400HH5	75F400HH5
3/4 X 4 1/2	10	75C450HH5	75F450HH5
3/4 X 5	10	75C500HH5	75F500HH5
3/4 X 5 1/2	10	75C550HH5	75F550HH5
3/4 X 6	10	75C600HH5	75F600HH5
3/4 X 6 1/2	10	75C650HH5	75F650HH5
3/4 X 7	10	75C700HH5	75F700HH5
3/4 X 7 1/2	10	75C750HH5	75F750HH5
3/4 X 8	10	75C800HH5	75F800HH5
3/4 X 8 1/2	10	75C850HH5	75F850HH5
3/4 X 9	10	75C900HH5	75F900HH5
3/4 X 9 1/2	10	75C950HH5	75F950HH5
3/4 X 10	10	75C1000HH5	75F1000HH5

Size	Pkg Qty	UNC 7/8-9	UNF 7/8-14
7/8 X 1 1/2	15	87C150HH5	87F150HH5
7/8 X 1 3/4	15	87C175HH5	87F175HH5
7/8 X 2	15	87C200HH5	87F200HH5
7/8 X 2 1/4	15	87C225HH5	87F225HH5
7/8 X 2 1/2	15	87C250HH5	87F250HH5
7/8 X 2 3/4	15	87C275HH5	87F275HH5
7/8 X 3	15	87C300HH5	87F300HH5
7/8 X 3 1/4	15	87C325HH5	87F325HH5
7/8 X 3 1/2	15	87C350HH5	87F350HH5
7/8 X 3 3/4	15	87C375HH5	87F375HH5
7/8 X 4	15	87C400HH5	87F400HH5
7/8 X 4 1/2	10	87C450HH5	87F450HH5
7/8 X 5	10	87C500HH5	87F500HH5
7/8 X 5 1/2	10	87C550HH5	87F550HH5
7/8 X 6	10	87C600HH5	87F600HH5
7/8 X 6 1/2	10	87C650HH5	87F650HH5
7/8 X 7	10	87C700HH5	87F700HH5
7/8 X 7 1/2	10	87C750HH5	87F750HH5
7/8 X 8	10	87C800HH5	87F800HH5
7/8 X 8 1/2	10	87C850HH5	87F850HH5
7/8 X 9	10	87C900HH5	87F900HH5
7/8 X 9 1/2	10	87C950HH5	87F950HH5
7/8 X 10	10	87C1000HH5	87F1000HH5

Size	Pkg Qty	UNC 1-8	UNF 1-14
1 X 1 1/2	10	100C150HH5	100F150HH5
1 X 1 3/4	10	100C175HH5	100F175HH5
1 X 2	10	100C200HH5	100F200HH5
1 X 2 1/4	10	100C225HH5	100F225HH5
1 X 2 1/2	10	100C250HH5	100F250HH5
1 X 2 3/4	10	100C275HH5	100F275HH5
1 X 3	10	100C300HH5	100F300HH5
1 X 3 1/4	10	100C325HH5	100F325HH5
1 X 3 1/2	10	100C350HH5	100F350HH5
1 X 3 3/4	10	100C375HH5	100F375HH5
1 X 4	10	100C400HH5	100F400HH5
1 X 4 1/2	10	100C450HH5	100F450HH5
1 X 5	10	100C500HH5	100F500HH5
1 X 5 1/2	10	100C550HH5	100F550HH5
1 X 6	10	100C600HH5	100F600HH5
1 X 6 1/2	10	100C650HH5	100F650HH5
1 X 7	10	100C700HH5	100F700HH5
1 X 7 1/2	5	100C750HH5	100F750HH5

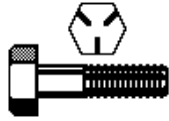

**HEX CAP SCREWS GR-5  
DOMESTIC - ZINC PLATED  
TENSILE STRENGTH 120,000 PSI**

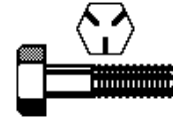

Size	Pkg Qty	UNC 1-8	UNF 1-14
1-8 X 8	5	100C800HH5	100F800HH5
1-8 X 8 1/2	5	100C850HH5	100F850HH5
1-8 X 9	5	100C900HH5	100F900HH5
1-8 X 9 1/2	5	100C950HH5	100F950HH5
1-8 X 10	5	100C1000HH5	100F1000HH5

Size	Pkg Qty	UNC 1 1/4-7	UNF 1 1/4-12
1 1/4 X 2	5	125C200HH5	125F200HH5
1 1/4 X 2 1/4	5	125C225HH5	125F225HH5
1 1/4 X 2 1/2	5	125C250HH5	125F250HH5
1 1/4 X 2 3/4	5	125C275HH5	125F275HH5
1 1/4 X 3	5	125C300HH5	125F300HH5
1 1/4 X 3 1/2	5	125C350HH5	125F350HH5
1 1/4 X 4	5	125C400HH5	125F400HH5
1 1/4 X 4 1/2	5	125C450HH5	125F450HH5
1 1/4 X 5	5	125C500HH5	125F500HH5
1 1/4 X 5 1/2	5	125C550HH5	125F550HH5
1 1/4 X 6	5	125C600HH5	125F600HH5
1 1/4 X 6 1/2	5	125C650HH5	125F650HH5
1 1/4 X 7	5	125C700HH5	125F700HH5
1 1/4 X 7 1/2	5	125C750HH5	125F750HH5
1 1/4 X 8	5	125C800HH5	125F800HH5
1 1/4 X 8 1/2	5	125C850HH5	125F850HH5
1 1/4 X 9	5	125C900HH5	125F900HH5
1 1/4 X 9 1/2	5	125C950HH5	125F950HH5
1 1/4 X 10	5	125C1000HH5	125F1000HH5

Size	Pkg Qty	UNC 1 1/8-7	UNF 1 1/8-12
1 1/8 x 2	5	112C200HH5	112F200HH5
1 1/8 x 2 1/4	5	112C225HH5	112F225HH5
1 1/8 x 2 1/2	5	112C250HH5	112F250HH5
1 1/8 x 2 3/4	5	112C275HH5	112F275HH5
1 1/8 x 3	5	112C300HH5	112F300HH5
1 1/8 x 3 1/4	5	112C325HH5	112F325HH5
1 1/8 x 3 1/2	5	112C350HH5	112F350HH5
1 1/8 x 3 3/4	5	112C375HH5	112F375HH5
1 1/8 x 4	5	112C400HH5	112F400HH5
1 1/8 x 4 1/2	5	112C450HH5	112F450HH5
1 1/8 x 5	5	112C500HH5	112F500HH5
1 1/8 x 5 1/2	5	112C550HH5	112F550HH5
1 1/8 x 6	5	112C600HH5	112F600HH5
1 1/8 x 6 1/2	5	112C650HH5	112F650HH5
1 1/8 x 7	5	112C700HH5	112F700HH5
1 1/8 x 7 1/2	5	112C750HH5	112F750HH5
1 1/8 x 8	5	112C800HH5	112F800HH5
1 1/8 x 8 1/2	5	112C850HH5	112F850HH5
1 1/8 x 9	5	112C900HH5	112F900HH5
1 1/8 x 9 1/2	5	112C950HH5	112F950HH5
1 1/8 x 10	5	112C1000HH5	112F1000HH5

**WE ARE  
UNLIMITED SUPPLIES  
IF YOU NEED AN ITEM NOT LISTED PLEASE CALL  
WE WILL BE HAPPY TO HELP**

UNLIMITED SUPPLIES

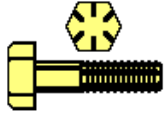

## HEX CAP SCREWS GR-8 DOMESTIC - DICHROMATE PLATED TENSILE STRENGTH 150,000 PSI

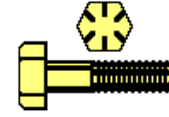

Size	Pkg Qty	UNC 1/4-20	UNF 1/4-28
1/4 X 1/2	100	25C50HH8	25F50HH8
1/4 X 5/8	100	25C62HH8	25F62HH8
1/4 X 3/4	100	25C75HH8	25F75HH8
1/4 X 7/8	100	25C87HH8	25F87HH8
1/4 X 1	100	25C100HH8	25F100HH8
1/4 X 1 1/4	100	25C125HH8	25F125HH8
1/4 X 1 1/2	100	25C150HH8	25F150HH8
1/4 X 1 3/4	100	25C175HH8	25F175HH8
1/4 X 2	100	25C200HH8	25F200HH8
1/4 X 2 1/4	50	25C225HH8	25F225HH8
1/4 X 2 1/2	50	25C250HH8	25F250HH8
1/4 X 2 3/4	50	25C275HH8	25F275HH8
1/4 X 3	50	25C300HH8	25F300HH8
1/4 X 3 1/4	50	25C325HH8	25F325HH8
1/4 X 3 1/2	50	25C350HH8	25F350HH8
1/4 X 3 3/4	50	25C375HH8	25F375HH8
1/4 X 4	50	25C400HH8	25F400HH8
1/4 X 4 1/2	50	25C450HH8	25F450HH8
1/4 X 5	50	25C500HH8	25F500HH8
1/4 X 5 1/2	50	25C550HH8	25F550HH8
1/4 X 6	50	25C600HH8	25F600HH8
1/4 X 7	25	25C700HH8	25F700HH8
1/4 X 8	25	25C800HH8	25F800HH8

Size	Pkg Qty	UNC 5/16-18	UNF 5/16-24
5/16 X 1/2	100	31C50HH8	31F50HH8
5/16 X 5/8	100	31C62HH8	31F62HH8
5/16 X 3/4	100	31C75HH8	31F75HH8
5/16 X 7/8	100	31C87HH8	31F87HH8
5/16 X 1	100	31C100HH8	31F100HH8
5/16 X 1 1/4	100	31C125HH8	31F125HH8
5/16 X 1 1/2	100	31C150HH8	31F150HH8
5/16 X 1 3/4	100	31C175HH8	31F175HH8
5/16 X 2	100	31C200HH8	31F200HH8
5/16 X 2 1/4	50	31C225HH8	31F225HH8
5/16 X 2 1/2	50	31C250HH8	31F250HH8
5/16 X 2 3/4	50	31C275HH8	31F275HH8
5/16 X 3	50	31C300HH8	31F300HH8
5/16 X 3 1/4	50	31C325HH8	31F325HH8
5/16 X 3 1/2	50	31C350HH8	31F350HH8
5/16 X 3 3/4	50	31C375HH8	31F375HH8
5/16 X 4	50	31C400HH8	31F400HH8

Size	Pkg Qty	UNC 5/16-18	UNF 5/16-24
5/16 X 4 1/2	50	31C450HH8	31F450HH8
5/16 X 5	50	31C500HH8	31F500HH8
5/16 X 5 1/2	50	31C550HH8	31F550HH8
5/16 X 6	50	31C600HH8	31F600HH8
5/16 X 7	50	31C700HH8	31F700HH8
5/16 X 8	25	31C800HH8	31F800HH8

Size	Pkg Qty	UNC 3/8-16	UNF 3/8-24
3/8 X 1/2	100	37C50HH8	37F50HH8
3/8 X 5/8	100	37C62HH8	37F62HH8
3/8 X 3/4	100	37C75HH8	37F75HH8
3/8 X 7/8	100	37C87HH8	37F87HH8
3/8 X 1	100	37C100HH8	37F100HH8
3/8 X 1 1/4	100	37C125HH8	37F125HH8
3/8 X 1 1/2	100	37C150HH8	37F150HH8
3/8 X 1 3/4	50	37C175HH8	37F175HH8
3/8 X 2	50	37C200HH8	37F200HH8
3/8 X 2 1/4	50	37C225HH8	37F225HH8
3/8 X 2 1/2	50	37C250HH8	37F250HH8
3/8 X 2 3/4	50	37C275HH8	37F275HH8
3/8 X 3	50	37C300HH8	37F300HH8
3/8 X 3 1/4	25	37C325HH8	37F325HH8
3/8 X 3 1/2	25	37C350HH8	37F350HH8
3/8 X 3 3/4	25	37C375HH8	37F375HH8
3/8 X 4	25	37C400HH8	37F400HH8
3/8 X 4 1/4	25	37C425HH8	37F425HH8
3/8 X 4 1/2	25	37C450HH8	37F450HH8
3/8 X 4 3/4	25	37C475HH8	37F475HH8
3/8 X 5	25	37C500HH8	37F500HH8
3/8 X 5 1/2	25	37C550HH8	37F550HH8
3/8 X 6	25	37C600HH8	37F600HH8
3/8 X 7	25	37C700HH8	37F700HH8
3/8 X 8	25	37F800HH8	37F800HH8

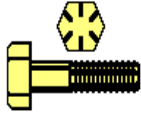

## HEX CAP SCREWS GR-8 DOMESTIC - DICHROMATE PLATED TENSILE STRENGTH 150.000 PSI

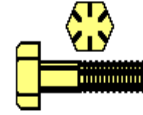

Size	Pkg Qty	UNC 7/16-14	UNF 7/16-20
7/16 X 3/4	50	43C75HH8	43F75HH8
7/16 X 7/8	50	43C87HH8	43F87HH8
7/16 X 1	50	43C100HH8	43F100HH8
7/16 X 1 1/4	50	43C125HH8	43F125HH8
7/16 X 1 1/2	50	43C150HH8	43F150HH8
7/16 X 1 3/4	50	43C175HH8	43F175HH8
7/16 X 2	50	43C200HH8	43F200HH8
7/16 X 2 1/4	25	43C225HH8	43F225HH8
7/16 X 2 1/2	25	43C250HH8	43F250HH8
7/16 X 2 3/4	25	43C275HH8	43F275HH8
7/16 X 3	25	43C300HH8	43F300HH8
7/16 X 3 1/4	25	43C325HH8	43F325HH8
7/16 X 3 1/2	25	43C350HH8	43F350HH8
7/16 X 3 3/4	25	43C375HH8	43F375HH8
7/16 X 4	25	43C400HH8	43F400HH8
7/16 X 4 1/2	25	43C450HH8	43F450HH8
7/16 X 5	25	43C500HH8	43F500HH8
7/16 X 5 1/2	25	43C550HH8	43F550HH8
7/16 X 6	25	43C600HH8	43F600HH8
7/16 X 7	25	43C700HH8	43F700HH8
7/16 X 8	25	73C800HH8	43F800HH8

Size	Pkg Qty	UNC 1/2-13	UNF 1/2-20
1/2 X 5	25	50C500HH8	50F500HH8
1/2 X 5 1/2	25	50C550HH8	50F550HH8
1/2 X 6	25	50C600HH8	50F600HH8
1/2 X 6 1/2	25	50C650HH8	50F650HH8
1/2 X 7	25	50C700HH8	50F700HH8
1/2 X 7 1/2	25	50C750HH8	50F750HH8
1/2 X 8	25	50C800HH8	50F800HH8

Size	Pkg Qty	UNC 9/16-12	UNF 9/16-18
9/16 X 1	25	56C100HH8	56F100HH8
9/16 X 1 1/4	25	56C125HH8	56F125HH8
9/16 X 1 1/2	25	56C150HH8	56F150HH8
9/16 X 1 3/4	25	56C175HH8	56F175HH8
9/16 X 2	25	56C200HH8	56F200HH8
9/16 X 2 1/4	25	56C225HH8	56F225HH8
9/16 X 2 1/2	25	56C250HH8	56F250HH8
9/16 X 2 3/4	25	56C275HH8	56F275HH8
9/16 X 3	25	56C300HH8	56F300HH8
9/16 X 3 1/4	25	56C325HH8	56F325HH8
9/16 X 3 1/2	25	56C350HH8	56F350HH8
9/16 X 3 3/4	25	56C375HH8	56F375HH8
9/16 X 4	25	56C400HH8	56F400HH8
9/16 X 4 1/2	25	56C450HH8	56F450HH8
9/16 X 5	25	56C500HH8	56F500HH8
9/16 X 5 1/2	25	56C550HH8	56F550HH8
9/16 X 6	25	56C600HH8	56F600HH8
9/16 X 6 1/2	25	56C650HH8	56F650HH8
9/16 X 7	25	56C700HH8	56F700HH8
9/16 X 7 1/2	25	56C750HH8	56F750HH8
9/16 X 8	25	56C800HH8	56F800HH8

Size	Pkg Qty	UNC 1/2-13	UNF 1/2-20
1/2 X 3/4	50	50C75HH8	50F75HH8
1/2 X 7/8	50	50C87HH8	50F87HH8
1/2 X 1	50	50C100HH8	50F100HH8
1/2 X 1 1/4	50	50C125HH8	50F125HH8
1/2 X 1 1/2	50	50C150HH8	50F150HH8
1/2 X 1 3/4	50	50C175HH8	50F175HH8
1/2 X 2	50	50C200HH8	50F200HH8
1/2 X 2 1/4	25	50C225HH8	50F225HH8
1/2 X 2 1/2	25	50C250HH8	50F250HH8
1/2 X 2 3/4	25	50C275HH8	50F275HH8
1/2 X 3	25	50C300HH8	50F300HH8
1/2 X 3 1/4	25	50C325HH8	50F325HH8
1/2 X 3 1/2	25	50C350HH8	50F350HH8
1/2 X 3 3/4	25	50C375HH8	50F375HH8
1/2 X 4	25	50C400HH8	50F400HH8
1/2 X 4 1/2	25	50C450HH8	50F450HH8

Size	Pkg Qty	UNC 5/8-11	UNF 5/8-18
5/8 X 1	25	62C100HH8	62F100HH8
5/8 X 1 1/4	25	62C125HH8	62F125HH8
5/8 X 1 1/2	25	62C150HH8	62F150HH8
5/8 X 1 3/4	25	62C175HH8	62F175HH8
5/8 X 2	25	62C200HH8	62F200HH8
5/8 X 2 1/4	25	62C225HH8	26F225HH8
5/8 X 2 1/2	25	62C250HH8	62F250HH8
5/8 X 2 3/4	25	62C275HH8	62F275HH8

UNLIMITED SUPPLIES



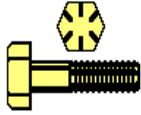

## HEX CAP SCREWS GR-8 DOMESTIC - DICHROMATE PLATED TENSILE STRENGTH 150.000 PSI

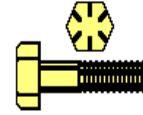

Size	Pkg Qty	UNC 5/8-11	UNF 5/8-18
5/8 X 3	25	62C300HH8	62F300HH8
5/8 X 3 1/4	25	62C325HH8	62F325HH8
5/8 X 3 1/2	25	62C350HH8	62F350HH8
5/8 X 3 3/4	25	62C375HH8	62F375HH8
5/8 X 4	25	62C400HH8	62F400HH8
5/8 X 4 1/2	25	62C450HH8	62F450HH8
5/8 X 5	25	62C500HH8	62F500HH8
5/8 X 5 1/2	25	62C550HH8	62F550HH8
5/8 X 6	25	62C600HH8	62F600HH8
5/8 X 6 1/2	25	62C650HH8	62F650HH8
5/8 X 7	25	62C700HH8	62F700HH8
5/8 X 7 1/2	25	62C750HH8	62F750HH8
5/8 X 8	25	62C800HH8	62F800HH8
5/8 X 8 1/2	10	62C850HH8	62F850HH8
5/8 X 9	10	62C900HH8	62F900HH8
5/8 X 9 1/2	10	62C950HH8	62F950HH8
5/8 X 10	10	62C1000HH8	62F1000HH8

Size	Pkg Qty	UNC 3/4-10	UNF 3/4-16
3/4 X 9 1/2	10	75C950HH8	75F950HH8
3/4 X 10	10	75C1000HH8	75F1000HH8

Size	Pkg Qty	UNC 7/8-9	UNF 7/8-14
7/8 X 1 1/2	15	87C150HH8	87F150HH8
7/8 X 1 3/4	15	87C175HH8	87F175HH8
7/8 X 2	15	87C200HH8	87F200HH8
7/8 X 2 1/4	15	87C225HH8	87F225HH8
7/8 X 2 1/2	15	87C250HH8	87F250HH8
7/8 X 2 3/4	15	87C275HH8	87F275HH8
7/8 X 3	15	87C300HH8	87F300HH8
7/8 X 3 1/4	15	87C325HH8	87F325HH8
7/8 X 3 1/2	15	87C350HH8	87F350HH8
7/8 X 3 3/4	15	87C375HH8	87F375HH8
7/8 X 4	15	87C400HH8	87F400HH8
7/8 X 4 1/2	10	87C450HH8	87F450HH8
7/8 X 5	10	87C500HH8	87F500HH8
7/8 X 5 1/2	10	87C550HH8	87F550HH8
7/8 X 6	10	87C600HH8	87F600HH8
7/8 X 6 1/2	10	87C650HH8	87F650HH8
7/8 X 7	10	87C700HH8	87F700HH8
7/8 X 7 1/2	10	87C750HH8	87F750HH8
7/8 X 8	10	87C800HH8	87F800HH8
7/8 X 8 1/2	10	87C850HH8	87F850HH8
7/8 X 9	10	87C900HH8	87F900HH8
7/8 X 9 1/2	10	87C950HH8	87F950HH8
7/8 X 10	10	87C1000HH8	87F1000HH8

Size	Pkg Qty	UNC 3/4-10	UNF 3/4-16
3/4 X 1	25	75C100HH8	75F100HH8
3/4 X 1 1/4	25	75C125HH8	75F125HH8
3/4 X 1 1/2	25	75C150HH8	75F150HH8
3/4 X 1 3/4	25	75C175HH8	75F175HH8
3/4 X 2	25	75C200HH8	75F200HH8
3/4 X 2 1/4	25	75C225HH8	75F225HH8
3/4 X 2 1/2	25	75C250HH8	75F250HH8
3/4 X 2 3/4	25	75C275HH8	75F275HH8
3/4 X 3	25	75C300HH8	75F300HH8
3/4 X 3 1/4	25	75C325HH8	75F325HH8
3/4 X 3 1/2	25	75C350HH8	75F350HH8
3/4 X 3 3/4	25	75C375HH8	75F375HH8
3/4 X 4	25	75C400HH8	75F400HH8
3/4 X 4 1/2	10	75C450HH8	75F450HH8
3/4 X 5	10	75C500HH8	75F500HH8
3/4 X 5 1/2	10	75C550HH8	75F550HH8
3/4 X 6	10	75C600HH8	75F600HH8
3/4 X 6 1/2	10	75C650HH8	75F650HH8
3/4 X 7	10	75C700HH8	75F700HH8
3/4 X 7 1/2	10	75C750HH8	75F750HH8
3/4 X 8	10	75C800HH8	75F800HH8
3/4 X 8 1/2	10	75C850HH8	75F850HH8
3/4 X 9	10	75C900HH8	75F900HH8
3/4 X 10	10	75C1000HH8	75F1000HH8

Size	Pkg Qty	UNC 1-8	UNF 1-14
1-8 X 1 1/2	10	100C150HH8	100F150HH8
1-8 X 1 3/4	10	100C175HH8	100F175HH8
1-8 X 2	10	100C200HH8	100F200HH8
1-8 X 2 1/4	10	100C225HH8	100F225HH8
1-8 X 2 1/2	10	100C250HH8	100F250HH8
1-8 X 2 3/4	10	100C275HH8	100F275HH8
1-8 X 3	10	100C300HH8	100F300HH8
1-8 X 3 1/4	10	100C325HH8	100F325HH8
1-8 X 3 1/2	10	100C350HH8	100F350HH8
1-8 X 3 3/4	10	100C375HH8	100F375HH8
1-8 X 4	10	100C400HH8	100F400HH8
1-8 X 4 1/2	10	100C450HH8	100F450HH8

UNLIMITED SUPPLIES



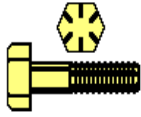

**HEX CAP SCREWS GR-8  
DOMESTIC - DICHROMATE PLATED  
TENSILE STRENGTH 150,000 PSI**

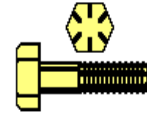

Size	Pkg Qty	UNC 1-8	UNF 1-14
1-8 X 5	10	100C500HH8	100F500HH8
1-8 X 5 1/2	10	100C550HH8	100F550HH8
1-8 X 6	10	100C600HH8	100F600HH8
1-8 X 6 1/2	10	100C650HH8	100F650HH8
1-8 X 7	10	100C700HH8	100F700HH8
1-8 X 7 1/2	5	100C750HH8	100F750HH8
1-8 X 8	5	100C800HH8	100F800HH8
1-8 X 8 1/2	5	100C850HH8	100F850HH8
1-8 X 9	5	100C900HH8	100F900HH8
1-8 X 9 1/2	5	100C950HH8	100F950HH8
1-8 X 10	5	100C1000HH8	100F1000HH8

Size	Pkg Qty	UNC 1 1/4-7	UNF 1 1/4-12
1 1/4 X 2	5	125C200HH8	125F200HH8
1 1/4 X 2 1/4	5	125C225HH8	125F225HH8
1 1/4 X 2 1/2	5	125C250HH8	125F250HH8
1 1/4 X 2 3/4	5	125C275HH8	125F275HH8
1 1/4 X 3	5	125C300HH8	125F300HH8
1 1/4 X 3 1/2	5	125C350HH8	125F350HH8
1 1/4 X 4	5	125C400HH8	125F400HH8
1 1/4 X 4 1/2	5	125C450HH8	125F450HH8
1 1/4 X 5	5	125C500HH8	125F500HH8
1 1/4 X 5 1/2	5	125C550HH8	125F550HH8
1 1/4 X 6	5	125C600HH8	125F600HH8
1 1/4 X 6 1/2	5	125C650HH8	125F650HH8
1 1/4 X 7	5	125C700HH8	125F700HH8
1 1/4 X 7 1/2	5	125C750HH8	125F750HH8
1 1/4 X 8	5	125C800HH8	125F800HH8
1 1/4 X 8 1/2	5	125C850HH8	125F850HH8
1 1/4 X 9	5	125C900HH8	125F900HH8
1 1/4 X 9 1/2	5	125C950HH8	125F950HH8
1 1/4 X 10	5	125C1000HH8	125F1000HH8

Size	Pkg Qty	UNC 1 1/8-7	UNF 1 1/8-12
1 1/8 X 2	5	112C200HH8	112F200HH8
1 1/8 X 2 1/4	5	112C225HH8	112F225HH8
1 1/8 X 2 1/2	5	112C250HH8	112F250HH8
1 1/8 X 2 3/4	5	112C275HH8	112F275HH8
1 1/8 X 3	5	112C300HH8	112F300HH8
1 1/8 X 3 1/4	5	112C325HH8	112F325HH8
1 1/8 X 3 1/2	5	112C350HH8	112F350HH8
1 1/8 X 3 3/4	5	112C375HH8	112F375HH8
1 1/8 X 4	5	112C400HH8	112F400HH8
1 1/8 X 4 1/2	5	112C450HH8	112F450HH8
1 1/8 X 5	5	112C500HH8	112F500HH8
1 1/8 X 5 1/2	5	112C550HH8	112F550HH8
1 1/8 X 6	5	112C600HH8	112F600HH8
1 1/8 X 6 1/2	5	112C650HH8	112F650HH8
1 1/8 X 7	5	112C700HH8	112F700HH8
1 1/8 X 7 1/2	5	112C750HH8	112F750HH8
1 1/8 X 8	5	112C800HH8	112F800HH8
1 1/8 X 8 1/2	5	112C850HH8	112F850HH8
1 1/8 X 9	5	112C900HH8	112F900HH8
1 1/8 X 9 1/2	5	112C950HH8	112F950HH8
1 1/8 X 10	5	112C1000HH8	112F1000HH8

**LARGER SIZES  
AVAILABLE UPON  
REQUEST**



## HEX CAP SCREWS GR-9 DOMESTIC - DICHROMATE PLATED TENSILE STRENGTH 180,000 PSI



Size	Pkg Qty	UNC 1/4-20	UNF 1/4-28
1/4 X 1/2	100	25C50HH9	25F50HH9
1/4 X 3/4	100	25C75HH9	25F75HH9
1/4 X 1	100	25C100HH9	25F100HH9
1/4 X 1 1/4	100	25C125HH9	25F125HH9
1/4 X 1 1/2	100	25C150HH9	25F150HH9
1/4 X 1 3/4	100	25C175HH9	-----
1/4 X 2	100	25C200HH9	25F200HH9
1/4 X 2 1/2	100	25C250HH9	25F250HH9
1/4 X 3	100	25C300HH9	25F300HH9

Size	Pkg Qty	UNC 7/16-14	UNF 7/16-20
7/16 X 3/4	100	43C75HH9	-----
7/16 X 1	100	43C100HH9	43F100HH9
7/16 X 1 1/4	50	43C125HH9	43F125HH9
7/16 X 1 1/2	50	43C150HH9	43F150HH9
7/16 X 1 3/4	50	43C175HH9	43F175HH9
7/16 X 2	50	43C200HH9	43F200HH9
7/16 X 2 1/2	50	43C250HH9	43F250HH9
7/16 X 3	50	43C300HH9	43F300HH9
7/16 X 3 1/2	25	43C350HH9	43F350HH9
7/16 X 4	25	43C400HH9	43F400HH9
7/16 X 5	25	43C500HH9	-----
7/16 X 6	25	43C600HH9	-----

Size	Pkg Qty	UNC 5/16-18	UNF 5/16-24
5/16 X 1/2	100	31C50HH9	-----
5/16 X 3/4	100	31C75HH9	31F75HH9
5/16 X 1	100	31C100HH9	31F100HH9
5/16 X 1 1/4	100	31C125HH9	31F125HH9
5/16 X 1 1/2	100	31C150HH9	31F150HH9
5/16 X 1 3/4	100	31C175HH9	31F175HH9
5/16 X 2	100	31C200HH9	31F200HH9
5/16 X 2 1/2	100	31C250HH9	31F250HH9
5/16 X 3	100	31C300HH9	31F300HH9
5/16 X 3 1/2	50	31C350HH9	-----
5/16 X 4	50	31C400HH9	-----

Size	Pkg Qty	UNC 1/2-13	UNF 1/2-20
1/2 X 3/4	50	50C75HH9	-----
1/2 X 1	50	50C100HH9	50F100HH9
1/2 X 1 1/4	50	50C125HH9	50F125HH9
1/2 X 1 1/2	50	50C150HH9	50F150HH9
1/2 X 1 3/4	50	50C175HH9	50F175HH9
1/2 X 2	50	50C200HH9	50F200HH9
1/2 X 2 1/4	50	50C225HH9	50F225HH9
1/2 X 2 1/2	50	50C250HH9	50F250HH9
1/2 X 3	50	50C300HH9	50F300HH9
1/2 X 3 1/2	50	50C350HH9	50F350HH9
1/2 X 4	25	50C400HH9	50F400HH9
1/2 X 4 1/2	25	50C450HH9	-----
1/2 X 5	25	50C500HH9	50F500HH9
1/2 X 6	25	50C600HH9	50F600HH9
1/2 X 7	25	50C700HH9	50F700HH9
1/2 X 8	25	50C800HH9	50F800HH9

Size	Pkg Qty	UNC 3/8-16	UNF 3/8-24
3/8 X 1/2	100	37C50HH9	-----
3/8 X 3/4	100	37C75HH9	37F75HH9
3/8 X 1	100	37C100HH9	37F100HH9
3/8 X 1 1/4	100	37C125HH9	37F125HH9
3/8 X 1 1/2	100	37C150HH9	37F150HH9
3/8 X 1 3/4	100	37C175HH9	37F175HH9
3/8 X 2	100	37C200HH9	37F200HH9
3/8 X 2 1/4	50	37C225HH9	37F225HH9
3/8 X 2 1/2	50	37C250HH9	37F250HH9
3/8 X 3	50	37C300HH9	37F300HH9
3/8 X 3 1/2	50	37C350HH9	37F350HH9
3/8 X 4	50	37C400HH9	37F400HH9
3/8 X 4 1/2	50	37C450HH9	-----
3/8 X 5	50	37C500HH9	-----
3/8 X 6	50	37C600HH9	-----

Size	Pkg Qty	UNC 9/16-12	UNF 9/16-18
9/16 X 1	25	56C100HH9	-----
9/16 X 1 1/2	25	56C150HH9	56F150HH9
9/16 X 2	25	56C200HH9	56F200HH9
9/16 X 2 1/2	25	56C250HH9	56F250HH9
9/16 X 3	25	56C300HH9	56F300HH9
9/16 X 3 1/2	25	56C350HH9	56F350HH9
9/16 X 4	25	56C400HH9	56F400HH9
9/16 X 5	25	56C500HH9	-----

UNLIMITED SUPPLIES



## HEX CAP SCREWS GR-9 DOMESTIC - DICHROMATE PLATED TENSILE STRENGTH 180,000 PSI



Size	Pkg Qty	UNC 5/8-11	UNF 5/8-18
5/8 X 1	25	62C100HH9	62F100HH9
5/8 X 1 1/4	25	62C125HH9	-----
5/8 X 1 1/2	25	62C150HH9	62F150HH9
5/8 X 1 3/4	25	62C175HH9	62F175HH9
5/8 X 2	25	62C200HH9	62F200HH9
5/8 X 2 1/4	25	62C225HH9	62F225HH9
5/8 X 2 1/2	25	62C250HH9	62F250HH9
5/8 X 2 3/4	25	62C275HH9	62F275HH9
5/8 X 3	25	62C300HH9	62F300HH9
5/8 X 3 1/2	25	62C350HH9	62F350HH9
5/8 X 4	25	62C400HH9	62F400HH9
5/8 X 4 1/2	25	62C450HH9	62F450HH9
5/8 X 5	25	62C500HH9	62F500HH9
5/8 X 6	25	62C600HH9	62F600HH9
5/8 X 7	25	62C700HH9	62F700HH9
5/8 X 8	25	62C800HH9	62F800HH9
5/8 X 9	25	62C900HH9	62F900HH9
5/8X 10	25	62C1000HH9	-----
5/8X 12	20	62C1200HH9	-----

Size	Pkg Qty	UNC 7/8-9	UNF 7/8-14
7/8 X 2	15	87C200HH9	87F200HH9
7/8 X 2 1/2	15	87C250HH9	87F250HH9
7/8 X 3	15	87C300HH9	87F300HH9
7/8 X 3 1/2	15	87C350HH9	87F350HH9
7/8 X 4	15	87C400HH9	87F400HH9
7/8 X 4 1/2	15	87C450HH9	87F450HH9
7/8 X 5	15	87C500HH9	87F500HH9
7/8 X 5 1/2	15	87C550HH9	87F550HH9
7/8 X 6	15	87C600HH9	78F600HH9
7/8 X 7	15	87C700HH9	87F700HH9
7/8 X 8	15	87C800HH9	87F800HH9
7/8 X 9	15	87C900HH9	87F900HH9
7/8 X 10	15	87C1000HH9	87F1000HH9
7/8X 11	15	87C1100HH9	78F1100HH9
7/8 X 12	12	87C1200HH9	87F1200HH9

Size	Pkg Qty	UNC 3/4-10	UNF 3/4-16
3/4 X 1 1/2	20	75C150HH9	75F150HH9
3/4 X 1 3/4	20	75C175HH9	75F175HH9
3/4 X 2	20	75C200HH9	75F200HH9
3/4 X 2 1/4	20	75C225HH9	75F225HH9
3/4 X 2 1/2	20	75C250HH9	75F250HH9
3/4 X 2 3/4	20	75C275HH9	75F275HH9
3/4 X 3	20	75C300HH9	75F300HH9
3/4 X 3 1/2	20	75C350HH9	75F350HH9
3/4 X 4	20	75C400HH9	75F400HH9
3/4 X 4 1/2	20	75C450HH9	75F450HH9
3/4 X 5	20	75C500HH9	75F500HH9
3/4 X 5 1/2	20	75C550HH9	75F550HH9
3/4 X 6	20	75C600HH9	75F600HH9
3/4 X 7	20	75C700HH9	75F700HH9
3/4 X 8	20	75C800HH9	75F800HH9
3/4 X 9	20	75C900HH9	75F900HH9
3/4 X 10	15	75C1000HH9	75F1000HH9
3/4 X 11	15	75C1100HH9	75F1100HH9
3/4 X 12	15	75C1200HH9	75F1200HH9

Size	Pkg Qty	UNC 1-8	UNF 1-14
1 X 2	10	100C200HH9	-----
1 X 2 1/2	10	100C250HH9	100F250HH9
1 X 3	10	100C300HH9	100F300HH9
1 X 3 1/2	10	100C350HH9	100F350HH9
1 X 4	10	100C400HH9	100F400HH9
1 X 4 1/2	10	100C450HH9	100F450HH9
1 X 5	10	100C500HH9	100F500HH9
1 X 5 1/2	10	100C550HH9	100F550HH9
1 X 6	10	100C600HH9	100F600HH9
1 X 7	10	100C700HH9	100F700HH9
1 X 8	10	100C800HH9	100F800HH9
1 X 9	8	100C900HH9	100F900HH9
1 X 10	8	100C1000HH9	100F1000HH9
1 X 11	8	100C1100HH9	100F1100HH9
1 X 12	8	100C1200HH9	100F1200HH9



**HEX CAP SCREWS GR-9  
DOMESTIC - DICHROMATE PLATED  
TENSILE STRENGTH 180,000 PSI**



Size	Pkg Qty	UNC 1 1/8-7	UNF 1 1/8-12
1 1/8 X 3	16	112C300HH9	112F300HH9
1 1/8 X 3 1/2	12	112C350HH9	112F350HH9
1 1/8 X 4	12	112C400HH9	112F400HH9
1 1/8 X 4 1/2	12	112C450HH9	112F450HH9
1 1/8 X 5	8	112C500HH9	112F500HH9
1 1/8 X 6	8	112C600HH9	112F600HH9
1 1/8 X 7	8	112C700HH9	112F700HH9
1 1/8 X 8	8	112C800HH9	112F800HH9
1 1/8 X 10	8	112C1000HH9	112F1000HH9

Size	Pkg Qty	UNC 1 1/4-7	UNF 1 1/4-12
1 1/4 X 3	12	125C300HH9	125F300HH9
1 1/4 X 3 1/2	8	125C350HH9	125F350HH9
1 1/4 X 4	8	125C400HH9	125F400HH9
1 1/4 X 4 1/2	8	125C450HH9	125F450HH9
1 1/4 X 5	6	125C500HH9	125F500HH9
1 1/4 X 5 1/2	6	125C550HH9	125F550HH9
1 1/4 X 6	6	125C600HH9	125F600HH9
1 1/4 X 7	6	125C700HH9	125F700HH9
1 1/4 X 8	6	125C800HH9	125F800HH9
1 1/4 X 9	6	125C900HH9	125F900HH9
1 1/4 X 10	6	125C1000HH9	125F1000HH9
1 1/4 X 11	4	125C1100HH9	125F1100HH9
1 1/4 X 12	4	125C1200HH9	125F1200HH9



Size	Pkg Qty	UNC 1 1/2-6	UNF 1 1/2-12
1 1/2 X 4	6	150C400HH9	150F400HH9
1 1/2 X 5	4	150C500HH9	150F500HH9
1 1/2 X 6	4	150C600HH9	150F600HH9
1 1/2 X 7	4	150C700HH9	150F700HH9
1 1/2 X 8	4	150C800HH9	150F800HH9
1 1/2 X 10	4	150C1000HH9	150F1000HH9
1 1/2 X 12	4	150C1200HH9	150F1200HH9

UNLIMITED SUPPLIES

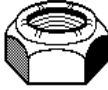
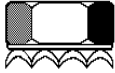



## HEX NUTS

		Hex Nut	Nyloc Nut	Keps Nut
Size	Pkg			
0-80	100	0CHN	OCNM5	---
2-56	100	2CHN	2CNM5	---
3-48	100	3CHN	3CNM5	---
4-40	100	4CHN	4CNM5	4CKN
5-40	100	5CHN	5CNM5	5CKN
6-32	100	6CHN	6CNM5	6CKN
8-32	100	8CHN	8CNM5	8CKN
10-24	100	10CHN	10CNM5	10CKN
10-32	100	10FHN	10FNM5	10FKN
12-24	100	12CHN	12CNM5	12CKN



## HEX NUTS - LOCK NUTS GR5

		USS Gr5 Hex Nut	Sae Gr5 Hex Nut	USS Gr5 Nyloc	SAE Gr5 Nyloc
Size	Pkg				
1/4	100	25CHN5	25FHN5	25CNI5	25FNI5
5/16	100	31CHN5	31FHN5	31CNI5	31FNI5
3/8	100	37CHN5	37FHN5	37CNI5	37FNI5
7/16	100	43CHN5	43FHN5	43CNI5	43FNI5
1/2	100	50CHN5	50FHN5	50CNI5	50FNI5
9/16	50	56CHN5	56FHN5	56CNI5	56FNI5
5/8	50	62CHN5	62FHN5	62CNI5	62FNI5
3/4	50	75CHN5	75FHN5	75CNI5	75FNI5
7/8	25	87CHN5	87FHN5	87CNI5	87FNI5
1	25	100CHN5	100FHN5	100CNI5	100FNI5
1 1/8	25	112CHN5	112FHN5	112CNI5	112FNI5
1 1/4	10	125CHN5	125FHN5	125CNI5	125FNI5
1 3/8	10	137CHN5	137FHN5		
1 1/2	10	150CHN5	150FHN5		

## HEX NUTS GR8 & L9

Size	Pkg	USS Gr8 Hex Nut	SAE Gr8 Hex Nut	USS L9 Hex Nut	SAE L9 Hex Nut
					
1/4	100	25CHN8	25FHN8	25CHN9	25FHN9
5/16	100	31CHN8	31FHN8	31CHN9	31FHN9
3/8	100	37CHN8	37FHN8	37CHN9	37FHN9
7/16	100	43CHN8	43FHN8	43CHN9	43FHN9
1/2	100	50CHN8	50FHN8	50CHN9	50FHN9
9/16	50	56CHN8	56FHN8	56CHN9	56FHN9
5/8	50	62CHN8	62FHN8	62CHN9	62FHN9
3/4	50	75CHN8	75FHN8	75CHN9	75FHN9
7/8	25	87CHN8	87FHN8	87CHN9	87FHN9
1	25	100CHN8	100FHN8	100CHN9	100FHN9
1 1/8	25	112CHN8	112FHN8	112CHN9	112FHN9
1 1/4	10	125CHN8	125FHN8	125CHN9	125FHN9
1 3/8	10	137CHN8	137FHN8	137CHN9	137FHN9
1 1/2	10	150CHN8	150FHN8	150CHN9	150FHN9

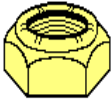
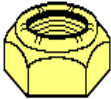
## LOCK NUTS GR8

Size	Pkg	USS GR8 Nyloc	SAE Gr8 Nyloc	USS Gr8 All Metal	SAE Gr8 All Metal
					
1/4	100	25CNI8	25FNI8	25CLN8	25FLN8
5/16	100	31CNI8	31FNI8	31CLN8	31FLN8
3/8	100	37CNI8	37FNI8	37CLN8	37FLN8
7/16	100	43CNI8	43FNI8	43CLN8	43FLN8
1/2	100	50CNI8	50FNI8	50CLN8	50FLN8
9/16	50	56CNI8	56FNI8	56CLN8	56FLN8
5/8	50	62CNI8	62FNI8	62CLN8	62FLN8
3/4	50	75CNI8	75FNI8	75CLN8	75FLN8
7/8	25	87CNI8	87FNI8	87CLN8	87FLN8
1	25	100CNI8	100FNI8	100CLN8	100FLN8
1 1/8	25	112CNI8	112FNI8	112CLN8	112FLN8
1 1/4	10	125CNI8	125FNI8	125CLN8	125FLN8
1 3/8	10	137CNI8	137FNI8	137CNE8	137FLN8
1 1/2	10	150CNI8	150FNI8	150CNE8	150FLN8

<b>HEX JAM NUTS</b>			
SIZE	Pkg	USS	SAE
1/4	100	25CHJN	25FHJN
5/16	100	31CHJN	31FHJN
3/8	100	37CHJN	37FHJN
7/16	100	43CHJN	43FHJN
1/2	100	50CHJN	50FHJN
9/16	50	56CHJN	56FHJN
5/8	50	62CHJN	62FHJN
3/4	50	75CHJN	75FHJN
7/8	25	87CHJN	87FHJN
1	25	100CHJN	100FHJN
1 1/8	25	112CHJN	112FHJN
1 1/4	25	125CHJN	125FHJN
1 3/8	10	137CHJN	137FHJN
1 1/2	10	150CHJN	150FHJN

<b>HEAVY HEX NUTS GRADE 2H</b>			
SIZE	Pkg	USS	SAE
1/4	100	25CHN2H	25FHN2H
5/16	100	31CHN2H	31FHN2H
3/8	100	37CHN2H	37FHN2H
7/16	100	43CHN2H	43FHN2H
1/2	100	50CHN2H	50FHN2H
9/16	50	56CHN2H	56FHN2H
5/8	50	62CHN2H	62FHN2H
3/4	25	75CHN2H	75FHN2H
7/8	25	87CHN2H	87FHN2H
1	25	100CHN2H	100FHN2H
1 1/8	25	112CHN2H	112FHN2H
1 1/4	15	125CHN2H	125FHN2H
1 3/8	10	137CHN2H	137FHN2H
1 1/2	10	150CHN2H	150FHN2H

<b>HEX NUTS</b>			
SIZE	Pkg	CASTLE USS	SLOTTED SAE
1/4	100	25CCN	25FCN
5/16	100	31CCN	31FCN
3/8	100	37CCN	37FCN
7/16	100	43CCN	43FCN
1/2	100	50CCN	50FCN
9/16	50	56CCN	56FCN
5/8	50	62CCN	62FCN
3/4	25	75CCN	75FCN
7/8	25	87CCN	87FCN
1	25	100CCN	100FCN
1 1/8	15	112CCN	112FCN
1 1/4	15	125CCN	125FCN
1 3/8	10	137CCN	137FCN
1 1/2	10	150CCN	150FCN

<b>HIGH NUTS HEAT TREATED</b>		
SIZE	Pkg	Part #
1/2-20	100	50FHIN
9/16-18	50	56FHIN
5/8-18	50	62FHIN
3/4-16	50	75FHIN
7/8-14	25	87FHIN
1-14	25	100FHIN
1 1/8-12	15	112FHIN
1 1/4-12	15	125FHIN
1 1/2-12	10	150FHIN

<b>HEX FLANGE NUTS</b>			
<b>Gr 8</b>			
			
SIZE	Pkg	USS	SAE
1/4	100	25CFN8	25FFN8
5/16	100	31CFN8	31FFN8
3/8	100	37CFN8	37FFN8
7/16	100	43CFN8	43FFN8
1/2	100	50CFN8	50FFN8
5/8	50	62CFN8	62FFN8
3/4	50	75CFN8	75FFN8
7/8	25	87CFN8	87FFN8
1	25	100CFN8	100FFN8

<b>HEX FLANGE LOCK NUTS Gr 8</b>			
			
SIZE	Pkg	USS	SAE
1/4	100	25CFLN8	25FFLN8
5/16	100	31CFLN8	31FFLN8
3/8	100	37CFLN8	37FFLN8
7/16	100	43CFLN8	43FFLN8
1/2	100	50CFLN8	50FFLN8
5/8	50	62CFLN8	62FFLN8
3/4	50	75CFLN8	75FFLN8
7/8	50	87CFLN8	87FFLN8
1	25	100CFLN8	100FFLN8

<b>SERRATED FLANGE NUTS</b>		
		
SIZE	Pkg	PART #
6-32	100	6CSFN
8-32	100	8CSFN
10-24	100	10CSFN
1/4-20	100	25CSFN
5/16-18	100	31CSFN
3/8-16	100	37CSFN
7/16-14	100	43CSFN
1/2-13	100	50CSFN
5/8-11	50	62CSFN
3/4-10	50	75CSFN
7/8-9	50	87CSFN
1-8	50	100CSFN

<b>WING NUTS</b>		
		
SIZE	Pkg	PART #
6-32	100	6CWN
8-32	100	8CWN
10-24	100	10CWN
10-32	100	10FWN
1/4-20	100	25CWN
1/4-28	100	25FWN
5/16-18	100	31CWN
3/8-16	100	37CWN
7/16-14	50	43CWN
1/2-13	50	50CWN
5/8-11	25	62CWN
3/4-10	25	75CWN
7/8-9	25	87CWN
1-8	25	100CWN



**HEX KEPS  
LOCK NUTS**



SIZE	Pkg	UNC	UNF
1/4	100	25CKN	25FKN
5/16	100	31CKN	31FKN
3/8	100	37CKN	37FKN

**COUPLING NUTS**

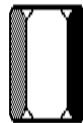

SIZE	Pkg	UNC	UNF
10	100	10CRCN	10FRCN
1/4	50	25CRCN	25FRCN
5/16	50	31CRCN	31FRCN
3/8	50	37CRCN	37FRCN
7/16	50	43CRCN	43FRCN
1/2	50	50CRCN	50FRCN
5/8	25	62CRCN	62FRCN
3/4	25	75CRCN	75FRCN
7/8	25	87CRCN	87FRCN
1	25	100CRCN	100FRCN
1 1/8	15	112CRCN	112FRCN
1 1/4	15	125CRCN	125FRCN
1 1/2	10	150CRCN	150FRCN

**T-NUT  
3 PRONG**



SIZE	Pkg	PART #
8-32	100	8CTN
10-24	100	10CTN
10-32	100	10FTN
1/4-20	100	25CTN
5/16-18	100	31CTN
3/8-16	100	37CTN

**FLEXLOC NUTS**



SIZE	Pkg	UNC	UNF
1/4	100	25CFLN	25FFLN
5/16	100	31CFLN	31FFLN
3/8	100	37CFLN	37FFLN
7/16	100	43CFLN	43FFLN
1/2	100	50CFLN	50FFLN
9/16	50	56CFLN	56FFLN
5/8	50	62CFLN	62FFLN
3/4	50	75CFLN	75FFLN
7/8	25	87CFLN	87FFLN
1	25	100CFLN	100FFLN

**ACORN NUTS**



SIZE	Pkg	UNC	UNF
6	100	6CAN	-----
8	100	8CAN	-----
10	100	10CAN	10FAN
12	100	12CAN	-----
1/4	100	25CAN	25FAN
5/16	100	31CAN	31FAN
3/8	100	37CAN	37FAN
7/16	50	43CAN	43FAN
1/2	50	50CAN	50FAN
5/8	50	62CAN	62FAN
3/4	25	75CAN	75FAN

## FLAT WASHERS

GRADE 2			
Size	Pkg Qty	SAE	USS
2	100	2SAE	----
3	100	3SAE	----
4	100	4SAE	----
5	100	5SAE	----
6	100	6SAE	----
8	100	8SAE	----
10	100	10SAE	----
12	100	12SAE	----
1/4	100	25SAE	25FW
5/16	100	31SAE	31FW
3/8	100	37SAE	37FW
7/16	100	43SAE	43FW
1/2	100	50SAE	50FW
9/16	50	56SAE	56FW
5/8	50	62SAE	62FW
3/4	50	75SAE	75FW
7/8	25	87SAE	87FW
1	25	100SAE	100FW
1 1/8	25	112SAE	112FW
1 1/4	25	125SAE	125FW
1 3/8	25	137SAE	137FW
1 1/2	25	150SAE	150FW

GRADE 8				
Size	Pkg Qty	SAE	USS	EXTRA THICK
1/4	100	25SAE8	25FW8	25ETFW8
5/16	100	31SAE8	31FW8	31ETFW8
3/8	100	37SAE8	37FW8	37ETFW8
7/16	100	43SAE8	43FW8	43ETFW8
1/2	100	50SAE8	50FW8	50ETFW8
9/16	50	56SAE8	56FW8	56ETFW8
5/8	50	62SAE8	62FW8	62ETFW8
3/4	50	75SAE8	75FW8	75ETFW8
7/8	25	87SAE8	87FW8	87ETFW8
1	25	100SAE8	100FW8	100ETFW8
1 1/8	25	112SAE8	112FW8	112ETFW8
1 1/4	25	125SAE8	125FW8	125ETFW8
1 3/8	25	137SAE8	137FW8	137ETFW8
1 1/2	25	150SAE8	150FW8	150ETFW8

COUNTERSUNK FINISHING WASHER		
Size	Pkg Qty	PART #
4	100	4FIN
6	100	6FIN
8	100	8FIN
10	100	10FIN
12	100	12FIN
1/4	100	25FIN
5/16	100	31FIN

FENDER WASHERS			
Size	Pkg Qty	PART #	1/8" THICK
1/8 X 1	100	12X100FDR	----
3/16 X 3/4	100	18X75FDR	----
3/16 X 1	100	18X100FDR	----
3/16 X 1 1/4	100	18X125FDR	----
1/4 X 1	100	25X100FDR	25X100X12FDR
1/4 X 1 1/4	100	25X125FDR	----
1/4 X 1 1/2	100	25X150FDR	25X150X12FDR
1/4 X 2	100	25X200FDR	----
5/16 X 1 1/4	100	31X125FDR	31X125X12FDR
5/16 X 1 1/2	100	31X150FDR	----
5/16 x 1 3/4	100	----	31X175X12FDR
5/16 X 2	100	31X200FDR	----
3/8 X 1 1/4	100	37X125FDR	37X125X12FDR
3/8 X 1 1/2	100	37X150FDR	----
3/8 x 1 3/4	50	----	37X175X12FDR
3/8 X 2	50	37X200FDR	----
1/2 X 1 1/2	50	50X150FDR	----
1/2 X 2	50	50X200FDR	50X200X12FDR

## MACHINERY BUSHINGS

<span style="font-size: 2em; vertical-align: middle;">NARROW RIM</span>				
Size	Pkg Qty	10 Ga	14 Ga	18 Ga
7/8 X 1/2	50	50X78X10MB	50X78X14MB	50X78X18MB
1 X 5/8	50	62X100X10MB	62X100X14MB	62X100X18MB
1 1/4 X 3/4	50	75X125X10MB	75X125X14MB	75X125X18MB
1 3/8 X 7/8	50	87X137X10MB	87X137X14MB	87X137X18MB
1 1/2 X 1	50	100X150X10MB	100X150X14MB	100X150X18MB
1 3/4 X 1 1/8	50	112X175X10MB	112X175X14MB	112X175X18MB
1 7/8 X 1 1/4	50	125X187X10MB	125X187X14MB	125X187X18MB
2 1/8 X 1 1/2	25	150X212X10MB	150X212X14MB	150X212X18MB
2 3/8 X 1 5/8	25	162X237X10MB	162X237X14MB	----
2 1/2 X 1 3/4	25	175X250X10MB	175X250X14MB	----
2 7/8 X 1 7/8	25	187X287X10MB	187X287X14MB	----
3 X 2	25	200X300X10MB	200X300X14MB	----
3 1/8 X 2 1/8	25	212X312X10MB	212X312X14MB	----
3 1/4 X 2 1/4	25	225X325X10MB	225X325X14MB	----

<span style="font-size: 2em; vertical-align: middle;">WIDE RIM</span>				
Size	Pkg Qty	10 Ga	14 Ga	18 Ga
5/8 X 1 1/4	50	62X125X10MB	62X125X14MB	----
3/4 X 1 1/2	50	75X150X10MB	75X150X14MB	75X150X18MB
7/8 X 1 3/4	50	87X175X10MB	87X175X14MB	87X175X18MB
1 X 2	50	100X200X10MB	100X200X14MB	100X200X18MB
1 1/8 X 2 1/8	25	112X212X10MB	112X212X14MB	112X212X18MB
1 1/4 X 2 1/4	25	125X225X10MB	125X225X14MB	125X225X18MB
1 3/8 X 2 1/2	25	137X250X10MB	137X250X14MB	137X250X18MB
1 1/2 X 3	25	150X300X10MB	150X300X14MB	150X300X18MB
1 5/8 X 3 1/8	25	162X312X10MB	162X312X14MB	162X312X18MB
1 3/4 X 3 1/4	25	175X325X10MB	175X325X14MB	175X325X18MB
1 7/8 X 3 3/8	25	187X337X10MB	187X337X14MB	187X337X18MB
2 X 3 1/2	25	200X350X10MB	200X350X14MB	200X350X18MB
2 1/8 X 3 5/8	25	212X362X10MB	212X362X14MB	212X362X18MB
2 1/4 X 3 3/4	25	225X375X10MB	225X375X14MB	225X375X18MB
2 1/2 X 3 7/8	25	250X387X10MB	250X387X14MB	250X387X18MB
2 3/4 X 4	25	275X400X10MB	275X400X14MB	275X400X18MB
3 X 4 1/4	25	300X425X10MB	300X425X14MB	300X425X18MB



10 Ga .126-.142

14 Ga .068-.082

18 Ga .042-.054

UNLIMITED SUPPLIES

# LOCK WASHERS

				
Size	Pkg Qty	STANDARD	HIGH COLLAR	Gr 8 ALLOY
2	100	2LW	----	----
3	100	3LW	----	----
4	100	4LW	----	----
5	100	5LW	----	----
6	100	6LW	6HCLW	----
8	100	8LW	8HCLW	----
10	100	10LW	10HCLW	----
12	100	12LW	12HCLW	----
1.4	100	25LW	25HCLW	25LW8
5/16	100	31LW	31HCLW	31LW8
3/8	100	37LW	37HCLW	37LW8
7/16	100	43LW	43HCLW	43LW8
1/2	100	50LW	50HCLW	50LW8
9/16	50	56LW	56HCLW	56LW8
5/8	50	62LW	62HCLW	62LW8
3/4	50	75LW	75HCLW	75LW8
7/8	25	87LW	87HCLW	87LW8
1	25	100LW	100HCLW	100LW8
1 1/8	25	112LW	112HCLW	112LW8
1 1/4	25	125LW	125HCLW	125LW8
1 3/8	10	137LW	137HCLW	137LW8
1 1/2	10	150LW	150HCLW	150LW8

# LOCK WASHERS



Size	Pkg Qty	EXTERNAL	INTERNAL	EXT-INT	COUNTERSUNK
2	100	2ELW	2ILW	----	----
3	100	3ELW	3ILW	----	----
4	100	4ELW	4ILW	4EILW	----
5	100	5ELW	5ILW	----	----
6	100	6ELW	6ILW	6EILW	6CLW
8	100	8ELW	8ILW	8EILW	8CLW
10	100	10ELW	10ILW	10EILW	10CLW
12	100	12ELW	12ILW	12EILW	12CLW
1/4	100	25ELW	25ILW	25EILW	25CLW
5/16	100	31ELW	31ILW	31EILW	31CLW
3/8	100	37ELW	37ILW	37EILW	----
7/16	100	43ELW	43ILW	43EILW	----
1/2	100	50ELW	50ILW	50EILW	----
9/16	50	56ELW	56ILW	56EILW	----
5/8	50	62ELW	62ILW	62EILW	----
3/4	50	75ELW	75ILW	75EILW	----
7/8	25	87ELW	87ILW	----	----
1	25	100ELW	100ILW	----	----
1 1/8	25	112ELW	112ILW	----	----
1 1/4	25	125ELW	125ILW	----	----



## CARRIAGE BOLTS GR 2 ZINC PLATED



Size	Pkg Qty	PART#
10-24 X 1/2	100	10C50CB2
10-24 X 3/4	100	10C75CB2
10-24 X 1	100	10C100CB2
10-24 X 1 1/4	100	10C125CB2
10-24 X 1 1/2	100	10C150CB2
10-24 X 1 3/4	100	10C175CB2
10-24 X 2	100	10C200CB2
10-24 X 2 1/2	100	10C250CB2
10-34 X 3	100	10C300CB2
1/4-20 X 1/2	100	25C50CB2
1/4-20 X 3/4	100	25C75CB2
1/4-20 X 1	100	25C100CB2
1/4-20 X 1 1/4	100	25C125CB2
1/4-20 X 1 1/2	100	25C150CB2
1/4-20 X 1 3/4	100	25C175CB2
1/4-20 X 2	100	25C200CB2
1/4-20 X 2 1/4	100	25C225CB2
1/4-20 X 2 1/2	100	25C250CB2
1/4-20 X 2 3/4	100	25C275CB2
1/4-20 X 3	100	25C300CB2
1/4-20 X 3 1/2	50	25C350CB2
1/4-20 X 4	50	25C400CB2
1/4-20 X 4 1/2	50	25C450CB2
1/4-20 X 5	50	25C500CB2
1/4-20 X 5 1/2	50	25C550CB2
1/4-20 X 6	50	25C600CB2
1/4-20 X 7	50	25C700CB2
1/4-20 X 8	50	25C800CB2
5/16-18 X 1/2	100	31C50CB2
5/16-18 X 3/4	100	31C75CB2
5/16-18 X 1	100	31C100CB2
5/16-18 X 1 1/4	100	31C125CB2
5/16-18 X 1 1/2	100	31C150CB2
5/16-18 X 1 3/4	100	31C175CB2
5/16-18 X 2	100	31C200CB2
5/16-18 X 2 1/4	100	31C225CB2
5/16-18 X 2 1/2	100	31C250CB2
5/16-18 X 2 3/4	100	31C275CB2
5/16-18 X 3	50	31C300CB2
5/16-18 X 3 1/2	50	31C350CB2
5/16-18 X 4	50	31C400CB2
5/16-18 X 4 1/2	50	31C450CB2
25/16-18 X 5	50	31C500CB2
5/16-18 X 5 1/2	50	31C550CB2

Size	Pkg Qty	PART#
5/16-18 X 6	100	10C50CB2
5/16-18 X 7	100	10C75CB2
5/16-18 X 7	100	10C100CB2
5/16-18 X 8	100	10C125CB2
5/16-18 X 9	100	10C150CB2
5/16-18 X 10	100	10C175CB2
3/8-16 X 3/4	100	10C200CB2
3/8-16 X 1	100	10C250CB2
3/8-16 X 1 1/4	100	10C300CB2
3/8-16 X 1 1/2	100	25C50CB2
3/8-16 X 1 3/4	100	25C75CB2
3/8-16 X 2	100	25C100CB2
3/8-16 X 2 1/4	100	25C125CB2
3/8-16 X 2 1/2	100	25C150CB2
3/8-16 X 2 3/4	100	25C175CB2
3/8-16 X 3	100	25C200CB2
3/8-16 X 3 1/2	100	25C225CB2
3/8-16 X 4	100	25C250CB2
3/8-16 X 4 1/2	100	25C275CB2
3/8-16 X 5	100	25C300CB2
3/8-16 X 5 1/2	50	25C350CB2
3/8-16 X 6	50	25C400CB2
3/8-16 X 7	50	25C450CB2
3/8-16 X 8	50	25C500CB2
3/8-16 X 9	50	25C550CB2
3/8-16 X 10	50	25C600CB2
3/8-16 X 11	50	25C700CB2
3/8-16 X 12	50	25C800CB2
7/16-14 X 1	100	31C50CB2
7/16-14 X 1 1/4	100	31C75CB2
7/16-14 X 1 1/2	100	31C100CB2
7/16-14 X 1 3/4	100	31C125CB2
7/16-14 X 2	100	31C150CB2
7/16-14 X 2 1/2	100	31C175CB2
7/16-14 X 3	100	31C200CB2
7/16-14 X 3 1/2	100	31C225CB2
7/16-14 X 4	100	31C250CB2
7/16-14 X 4 1/2	100	31C275CB2
7/16-14 X 5	50	31C300CB2
7/16-14 X 5 1/2	50	31C300CB2
7/16-14 X 6	50	31C400CB2
1/2-13 X 1	50	31C450CB2
1/2-13 X 1 1/2	50	31C500CB2
1/2-13 X 1 3/4	50	31C550CB2

UNLIMITED SUPPLIES



## CARRIAGE BOLTS GR 2 ZINC PLATED



Size	Pkg Qty	PART#
1/2-13 X 2	50	50C200CB2
1/2-13 X 2 1/4	50	50C225CB2
1/2-13 X 2 1/2	25	50C250CB2
1/2-13 X 2 3/4	25	50C275CB2
1/2-13X 3	25	50C300CB2
1/2-13 X 3 1/2	25	50C350CB2
1/2-13 X 4	25	50C400CB2
1/2-13X 4 1/2	25	50C450CB2
1/2-13 X 5	25	50C500CB2
1/2-13 X 5 1/2	25	50C550CB2
1/2-13 X 6	25	50C600CB2
1/2-13 X 7	25	50C700CB2
1/2-13 X 8	25	50C800CB2
1/2-13 X 9	25	50C900CB2
1/2-1 3X 10	25	50C1000CB2
1/2-13 X 11	10	50C1100CB2
1/2-1 3X 12	10	50C1200CB2
5/8-11 X 1 1/2	25	62C150CB2
5/8-11 X 1 3/4	25	62C175CB2
5/8-11 X 2	25	62C200CB2
5/8-11 X 2 1/2	25	62C250CB2
5/8-11 X 3	25	62C300CB2
5/8-11 X 3 1/2	25	62C350CB2
5/8-11 X 4	25	62C400CB2
5/8-11 X 4 1/2	25	62C450CB2
5/8-11 X 5	25	62C500CB2
5/8-11 X 6	25	62C600CB2
5/8-11 X 7	25	62C700CB2
5/8-11 X 8	25	62C800CB2
5/8-11 X 9	25	62C900CB2
5/8-11 X 10	25	62C1000CB2
5/8-11 X 11	10	62C1100CB2
5/8-11 X 12	10	62C1200CB2

Size	Pkg Qty	PART#
3/4-10 X 2	25	75C200CB2
3/4-10 X 2 1/2	25	75C250CB2
3/4-10 X 3	25	75C300CB2
3/4-10 X 3 1/2	25	75C350CB2
3/4-10 X 4	25	75C400CB2
3/4-10 X 4 1/2	25	75C450CB2
3/4-10 X 5	10	75C500CB2
3/4-10 X 5 1/2	10	75C550CB2
3/4-10 X 6	10	75C600CB2
3/4-10 X 7	10	75C700CB2
3/4-10 X 8	10	75C800CB2
3/4-10 X 9	10	75C900CB2
3/4-10 X 10	10	75C1000CB2
3/4-10 X 11	10	75C1100CB2
3/4-10 X 12	10	75C1200CB2

## CARRIAGE BOLTS GR 5 SHAKER SCREEN BOLTS GR 8

Size	Pkg Qty	GR 5	GR 8
1/4-20 X 3/4	100	25C75CB5	----
1/4-20 X 1	100	25C100CB5	----
1/4-20 X 1 1/4	100	25C125CB5	----
1/4-20 X 1 1/2	100	25C150CB5	----
		25C175CB5	
1/4-20 X 1 3/4	100	25C200CB5	----
1/4-20 X 2	100	25C250CB5	----
1/4-20 X 2 1/2	100	25C300CB5	----
1/4-20 X 3	100		----
		25C350CB5	
1/4-20 X 3 1/2	100	25C400CB5	----
1/4-20 X 4	100	25C450CB5	----
1/4-20 X 4 1/2	100	25C500CB5	----
1/4-20 X 5	100		----
		25C600CB5	
1/4-20 X 6	100	31C75CB5	----
5/16-18 X 3/4	100	31C100CB5	----
5/16-18 X 1	100	31C125CB5	----
5/16-18 X 1 1/4	100		----
		31C150CB5	
5/16-18 X 1 1/2	100	31C175CB5	----
5/16-18 X 1 3/4	100	31C200CB5	----
5/16-18 X 2	100	31C250CB5	----
5/16-18 X 2 1/2	100		----
		31C275CB5	
5/16-18 X 3	100	31C350CB5	----
5/16-18 X 3 1/2	100	31C400CB5	----
5/16-18 X 4	100	37C75CB5	----
3/8-16 X 3/4	100		----
		37C100CB5	
3/8-16 X 1	100	37C125CB5	----
3/8-16 X 1 1/4	100	37C150CB5	----
3/8-16 X 1 1/2	100	37C175CB5	----
3/8-16 X 1 3/4	100		----
		37C200CB5	
3/8-16 X 2	100	37C225CB5	----
3/8-16 X 2 1/4	50	37C250CB5	----
3/8-16 X 2 1/2	50	37C275CB5	----
3/8-16 X 2 3/4	50		----
		37C300CB5	
3/8-16 X 3	50	37C350CB5	----
3/8-16 X 3 1/2	50	37C400CB5	----
3/8-16 X 4	50	43C100CB5	----
7/16-14 X 1	50		----
		43C125CB5	
7/16-14 X 1 1/4	50	43C150CB5	----
7/16-14 X 1 1/2	50	43C175CB5	----
7/16-14 X 1 3/4	50	43C200CB5	----
7/16-14 X 2	50		----
		43C250CB5	
7/16-14 X 2 1/2	50	43C300CB5	----
7/16-14 X 3	50		----

Size	Pkg Qty	GR 5	GR 8
7/16-14 X 3 1/2	50	43C350CB5	----
7/16-14 X 4	50	43C400CB5	----
1/2-13 X 1	50	50C100CB5	----
1/2-13 X 1 1/2	50	50C150CB5	50C150CB8
1/2-13 X 1 3/4	50	50C175CB5	50C175CB8
1/2-13 X 2	50	50C200CB5	50C200CB8
1/2-13 X 2 1/4	50	50C225CB5	----
1/2-13 X 2 1/2	25	50C250CB5	50C250CB8
1/2-13 X 3	25	50C300CB5	50C300CB8
1/2-13 X 3 1/2	25	50C350CB5	50C350CB8
1/2-13 X 4	25	50C400CB5	50C400CB8
1/2-13 X 4 1/2	25	50C450CB5	50C450CB8
1/2-13 X 5	25	50C500CB5	50C500CB8
1/2-13 X 6	25	----	50C600CB8
1/2-13 X 8	25	----	50C800CB8
5/8-11 X 1 1/2	25	62C150CB5	----
5/8-11 X 1 3/4	25	62C175CB5	----
5/8-11 X 2	25	62C200CB5	62C200CB8
5/8-11 X 2 1/2	25	62C250CB5	62C250CB8
5/8-11 X 3	25	62C300CB5	62C300CB8
5/8-11 X 3 1/2	25	62C350CB5	62C350CB8
5/8-11 X 4	25	62C400CB5	62C400CB8
5/8-11 X 4 1/2	25	62C450CB5	62C450CB8
5/8-11 X 5	25	62C500CB5	62C500CB8
5/8-11 X 5 1/2	25	62C550CB5	62C550CB8
5/8-11 X 6	25	62C600CB5	62C600CB8
5/8-11 X 8	20	----	62C800CB8
5/8-11 X 9	20	----	62C900CB8
5/8-11 X 10	20	----	62C1000CB8
3/4-10 X 2	20	75C200CB5	75C200CB8
3/4-10 X 2 1/2	20	75C250CB5	75C250CB8
3/4-10 X 3	20	75C300CB5	75C300CB8
3/4-10 X 3 1/2	20	75C350CB5	75C350CB8
3/4-10 X 4	20	75C400CB5	75C400CB8
3/4-10 X 4 1/2	20	75C450CB5	75C450CB8
3/4-10 X 5	20	75C500CB5	75C500CB8
3/4-10 X 5 1/2	20	----	75C550CB8
3/4-10 X 6	20	75C600CB5	75C600CB8
3/4-10 X 7	20	----	75C700CB8
3/4-10 X 8	20	----	75C800CB8
3/4-10 X 9	20	----	75C900CB8
3/4-10 X 10	20	----	75C1000CB8





ELEVATOR BOLT



STEP BOLT

Size	Pkg Qty	ELEVATOR BOLT	STEP BOLT
1/4-20 X 3/4	100	25C75ELB	25C75SB
1/4-20 X 1	100	25C100ELB	25C100SB
1/4-20 X 1 1/4	100	25C125ELB	25C125SB
1/4-20 X 1 1/2	100	25C150ELB	25C150SB
1/4-20 X 1 3/4	100	25C175ELB	25C175SB
1/4-20 X 2	100	25C200ELB	25C200SB
1/4-20 X 2 1/2	50	25C250ELB	25C250SB
1/4-20 X 3	50	25C300ELB	25C300SB
5/16-18 X 3/4	100	31C75ELB	31C75SB
5/16-18 X 1	100	31C100ELB	31C100SB
5/16-18 X 1 1/4	100	31C125ELB	31C125SB
5/16-18 X 1 1/2	100	31C150ELB	31C150SB
5/16-18 X 1 3/4	50	31C175ELB	31C175SB
5/16-18 X 2	50	31C200ELB	31C200SB
5/16-18 X 2 1/2	50	31C250ELB	31C250SB
5/16-18 X 3	50	31C300ELB	31C300SB
3/8-16 X 1	100	37C100ELB	37C100SB
3/8-16 X 1 1/4	100	37C125ELB	37C125SB
3/8-16 X 1 1/2	100	37C150ELB	37C150SB
3/8-16 X 1 3/4	50	37C175ELB	37C175SB
3/8-16 X 2	50	37C200ELB	37C200SB
3/8-16 X 2 1/2	50	37C250ELB	37C250SB
3/8-16 X 3	50	37C300ELB	37C300SB

<b>HANGER BOLTS</b>			
Size	Pkg Qty	PART#	
10-24 X 1 1/2	100	10C150HB	
10-24 X 2	100	10C200HB	
10-24 X 2 1/2	100	10C250HB	
10-24 X 3	100	10C300HB	
1/4-20 X 1 1/2	100	25C150HB	
1/4-20 X 1 3/4	100	25C175HB	
1/4-20 X 2	100	25C200HB	
1/4-20 X 2 1/2	50	25C250HB	
1/4-20 X 3	50	25C300HB	
1/4-20 X 3 1/2	50	25C350HB	
1/4-20 X 4	50	25C400HB	
1/4-20 X 5	50	25C500HB	

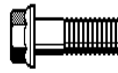

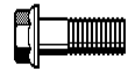

**FLANGE BOLTS  
GR 8**



Size	Pkg Qty	PART#
3/8-16 x 1	100	37C100FB8
3/8-16 x 1 1/4	100	37C125FB8
3/8-16 x 1 1/2	100	37C150FB8
3/8-16 x 1 3/4	50	37C175FB8
3/8-16 x 2	50	37C200FB8
1/2-13 x 1	50	50C100FB8
1/2-13 x 1 1/4	50	50C125FB8
1/2-13 x 1 1/2	50	50C150FB8
1/2-13 x 1 3/4	50	50C175FB8
1/2-13 x 2	50	50C200FB8
1/2-13 x 2 1/4	50	50C225FB8
1/2-13 x 2 1/2	25	50C250FB8
1/2-13 x 3	25	50C300FB8
1/2-13 x 3 1/2	25	50C350FB8
1/2-13 x 4	25	50C400FB8
5/8-11 x 1 1/4	25	62C125FB8
5/8-11 x 1 1/2	25	62C150FB8
5/8-11 x 1 3/4	25	62C175FB8
5/8-11 x 2	25	62C200FB8
5/8-11 x 2 1/4	25	62C225FB8
5/8-11 x 2 1/2	25	62C250FB8
5/8-11 x 3	25	62C300FB8
5/8-11 x 3 1/2	25	62C350FB8
5/8-11 x 4	25	62C400FB8
3/4-10 x 1 3/4	25	75C175FB8
3/4-10 x 2	25	75C200FB8
3/4-10 x 2 1/4	25	75C225FB8
3/4-10 x 2 1/2	25	75C250FB8
3/4-10 x 3	25	75C300FB8
3/4-10 x 3 1/2	25	75C350FB8
3/4-10 x 4	25	75C400FB8

<b>HANGER BOLTS</b>			
Size	Pkg Qty	PART#	
5/16-18 x 1 1/2	50	31C150HB	
5/16-18 x 1 3/4	50	31C175HB	
5/16-18 x 2	50	31C200HB	
5/16-18 x 2 1/2	50	31C250HB	

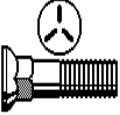
# PLOW BOLTS

	<b>GRADE 5</b>	
Size	Pkg Qty	PART#
3/8-16 x 1	100	37C100PB5
3/8-16 x 1 1/4	100	37C125PB5
3/8-16 x 1 1/2	100	37C150PB5
3/8-16 x 1 3/4	100	37C175PB5
3/8-16 x 2	100	37C200PB5
3/8-16 x 2 1/2	100	37C250PB5
3/8-16 x 3	50	37C300PB5
3/8-16 x 3 1/2	50	37C350PB5
3/8-16 x 4	50	37C400PB5
7/16-14 x 1	100	43C100PB5
7/16-14 x 1 1/4	100	43C125PB5
7/16-14 x 1 1/2	100	43C150PB5
7/16-14 x 1 3/4	100	43C175PB5
7/16-14 x 2	100	43C200PB5
7/16-14 x 2 1/2	100	43C250PB5
7/16-14 x 3	50	43C300PB5
7/16-14 x 3 1/2	50	43C350PB5
7/16-14 x 4	50	43C400PB5
1/2-13 x 1	100	50C100PB5
1/2-13 x 1 1/4	100	50C125PB5
1/2-13 x 1 1/2	100	50C150PB55
1/2-13 x 1 3/4	100	50C175PB5
1/2-13 x 2	50	50C200PB5
1/2-13 x 2 1/2	50	50C250PB5
1/2-13 x 3	50	50C300PB5
1/2-13 x 3 1/2	25	50C350PB5
1/2-13 x 4	25	62C150PB5
5/8-11 x 1 1/2	50	62C175PB5
5/8-11 x 1 3/4	50	62C200PB5
5/8-11 x 2	50	62C225PB5
5/8-11 x 2 1/4	25	62C250PB5
5/8-11 x 2 1/2	25	62C300PB5
5/8-11 x 3	25	62C350PB5
5/8-11 x 3 1/2	25	62C400PB5
5/8-11 x 4	25	62C400PB5

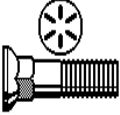
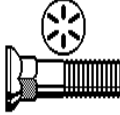
	<b>GRADE 8</b>	
Size	Pkg Qty	PART#
3/8-16 x 1 1/2	100	37C150PB8
1/2-13 x 1	100	50C100PB8
1/2-13 x 1 1/4	100	50C125PB8
1/2-13 x 1 1/2	100	50C150PB8
1/2-13 x 1 3/4	50	50C175PB8
1/2-13 x 2	50	50C200PB8
1/2-13 x 2 1/4	50	50C225PB8
1/2-13 x 2 1/2	50	50C250PB8
1/2-13 x 3	50	50C300PB8
1/2-13 x 3 1/2	25	50C350PB8
1/2-13 x 4	25	50C400PB8
5/8-11 x 1 1/2	50	62C150PB8
5/8-11 x 1 3/4	50	62C175PB8
5/8-11 x 2	50	62C200PB8
5/8-11 x 2 1/4	50	62C225PB8
5/8-11 x 2 1/2	25	62C250PB8
5/8-11 X 2 3/4	25	62C275PB8
5/8-11 x 3	25	62C300PB8
5/8-11 x 3 1/2	25	62C350PB8
5/8-11 x 4	25	62C400PB8
5/8-11 x 5	25	62C500PB8
5/8-11 x 6	25	62C600PB8
3/4-10 x 2	25	75C200PB8
3/4-10 x 2 1/4	25	75C225PB8
3/4-10 x 2 1/2	25	75C250PB8
3/4-10 x 2 3/4	25	75C275PB8
3/4-10 x 3	25	75C300PB8
3/4-10 x 3 1/2	25	75C350PB8
3/4-10 x 4	25	75C400PB8
3/4-10 x 5	25	75C500PB8
3/4-10 x 6	25	75C600PB8

UNLIMITED SUPPLIES

## PLOW BOLTS

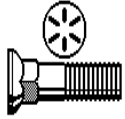

**GRADE  
8**

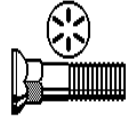

Size	Pkg Qty	PART#
7/8-9 x 2	10	87C200PB8
7/8-9 x 2 1/4	10	87C225PB8
7/8-9 x 2 1/2	10	87C250PB8
7/8-9 x 2 3/4	10	87C275PB8
7/8-9 x 3	10	87C300PB8
7/8-9 x 3 1/2	10	87C350PB8
7/8-9 x 4	10	87C400PB8
7/8-9 x 4 1/2	10	87C450PB8
7/8-9 x 5	10	87C500PB8
7/8-9 x 6	10	87C600PB8
7/8-9 x 7	10	87C700PB8
1-8 x 2 1/2	10	100C250PB8
1-8 x 2 3/4	10	100C275PB8
1-8 x 3	10	100C300PB8
1-8 x 3 1/2	10	100C350PB8
1-8 x 4	10	100C400PB8
1-8 x 5	10	100C500PB8
1-8 x 6	10	100C600PB8
1-8 x 7	10	100C700PB8
1 1/8-7 x 3 1/2	10	112C350PB8
1 1/8-7 x 4	10	112C400PB8
1 1/8-7 x 5	10	112C500PB8
1 1/8-7 x 6	10	112C600PB8
1 1/4-7 x 3	5	125C300PB8
1 1/4-7 x 4	5	125C400PB8
1 1/4-7 x 5	5	125C500PB8
1 1/4-7 x 6	5	125C600PB8
1 1/4-7 x 7	5	125C700PB8
1 1/4-7 x 8	5	125C800PB8

## DOWEL SCREW



Size	Pkg Qty	PART#
3/16 x 1 1/2	100	316X150DS
3/16 x 2	100	316X200DS
3/16 x 2 1/2	100	316X250DS
3/16 x 3	100	316X300DS
1/4 x 1 1/2	100	14X150DS
1/4 x 2	100	14X200DS
1/4 x 2 1/2	50	14X250DS
1/4 x 3	50	14X300DS
1/4 x 3 1/2	50	14X350DS
5/16 x 1 1/2	100	516X150DS
5/16 x 2	50	516X200DS
5/16 x 2 1/2	50	516X250DS
5/16 x 3	50	516X300DS
5/16 x 3 1/2	50	516X350DS
5/16 x 4	50	516X400DS
3/8 x 2 1/2	50	38X250DS
3/8 x 3	50	38X300DS
3/8 x 3 1/2	25	38X350DS
3/8 x 4	25	38X400DS

## SPADE LAG SCREW



Size	Pkg Qty	PART#
1/4 x 3	50	14X300SLB
1/4 x 4	50	14X400SLB
1/4 x 5	50	14X500SLB



# HEX LAG BOLTS

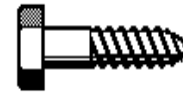

Size	Pkg Qty	PART#
1/4 x 1	100	14X100HLB
1/4 x 1 1/4	100	14X125HLB
1/4 x 1 1/2	100	14X150HLB
1/4 x 1 3/4	100	14X175HLB
1/4 x 2	100	14X200HLB
1/4 x 2 1/2	50	14X250HLB
1/4 x 3	50	14X300HLB
1/4 x 3 1/2	50	14X350HLB
1/4 x 4	50	14X400HLB
1/4 x 4 1/2	50	14X450HLB
1/4 x 5	50	14X500HLB
1/4 x 5 1/2	50	14X550HLB
1/4 x 6	50	14X600HLB
5/16 x 1	100	516X100HLB
5/16 x 1 1/4	100	516X125HLB
5/16 x 1 1/2	100	516X150HLB
5/16 x 1 3/4	100	516X175HLB
5/16 x 2	100	516X200HLB
5/16 x 2 1/2	50	516X250HLB
5/16 x 3	50	516X300HLB
5/16 x 3 1/2	50	516X350HLB
5/16 x 4	50	516X400HLB
5/16 x 4 1/2	50	516X450HLB
5/16 x 5	50	516X500HLB
5/16 x 5 1/2	50	516X550HLB
5/16 x 6	50	516X600HLB
3/8 x 1	100	38X100HLB
3/8 x 1 1/4	100	38X125HLB
3/8 x 1 1/2	100	38X150HLB
3/8 x 1 3/4	50	38X175HLB
3/8 x 2	50	38X200HLB
3/8 x 2 1/2	50	38X250HLB
3/8 x 3	50	38X300HLB
3/8 x 3 1/2	50	38X350HLB
3/8 x 4	50	38X400HLB
3/8 x 4 1/2	25	38X450HLB
3/8 x 5	25	38X500HLB
3/8 x 5 1/2	25	38X550HLB
3/8 x 6	25	38X600HLB
3/8 x 7	25	38X700HLB

Size	Pkg Qty	PART#
1/2 x 1 1/2	50	12X150HLB
1/2 x 1 3/4	50	12X175HLB
1/2 x 2	50	12X200HLB
1/2 x 2 1/2	25	12X250HLB
1/2 x 3	25	12X300HLB
1/2 x 3 1/2	25	12X350HLB
1/2 x 4	25	12X400HLB
1/2 x 4 1/2	25	12X450HLB
1/2 x 5	25	12X500HLB
1/2 x 5 1/2	25	12X550HLB
1/2 x 6	25	12X600HLB
1/2 x 7	25	12X700HLB
1/2 x 8	25	12X800HLB
1/2 x 10	25	12X1000HLB
5/8 x 2	25	58X200HLB
5/8 x 2 1/2	25	58X250HLB
5/8 x 3	25	58X300HLB
5/8 x 3 1/2	25	58X350HLB
5/8 x 4	25	58X400HLB
5/8 x 4 1/2	25	58X450HLB
5/8 x 5	25	58X500HLB
5/8 x 5 1/2	25	58X550HLB
5/8 x 6	25	58X600HLB
5/8 x 7	25	58X700HLB
5/8 x 8	25	58X800HLB
5/8 x 9	25	58X900HLB
5/8 x 10	10	58X1000HLB
5/8 x 12	10	58X1200HLB
3/4 x 2 1/2	25	34X250HLB
3/4 x 3	25	34X300HLB
3/4 x 3 1/2	25	34X350HLB
3/4 x 4	25	34X400HLB
3/4 x 5	10	34X500HLB
3/4 x 6	10	34X600HLB
3/4 x 7	10	34X700HLB
3/4 x 8	10	34X800HLB
3/4 x 10	10	34X1000HLB
3/4 x 12	10	34X1200HLB

# MACHINE SCREW HEAD STYLES



**PFM**  
**PHILLIPS FLAT**

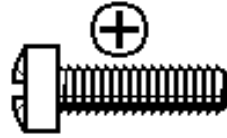

**PLM**  
**PHILLIPS FILLISTER**

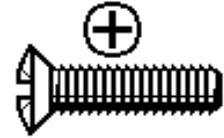

**POM**  
**PHILLIPS OVAL**



**PRM**  
**PHILLIPS ROUND**

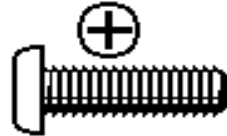

**PPM**  
**PHILLIPS PAN**

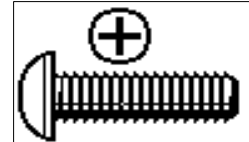

**PTM**  
**PHILLIPS TRUSS**

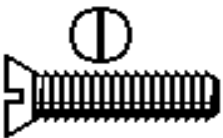

**SFM**  
**SLOTTED FLAT**

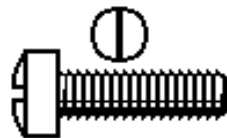

**SLM**  
**SLOTTED FILLISTER**

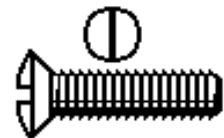

**SOM**  
**SLOTTED OVAL**

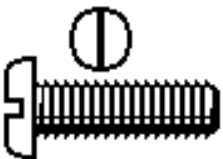

**SPM**  
**SLOTTED PAN**

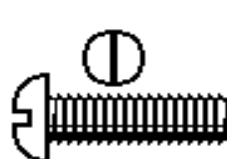

**SRM**  
**SLOTTED ROUND**

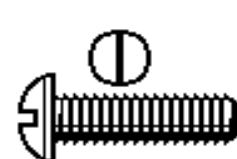

**STM**  
**SLOTTED TRUSS**

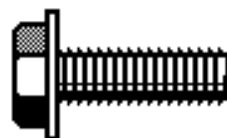

**UHM**  
**UNSLOTTED HEX**

# MACHINE SCREWS

Size	Pkg Qty	PART#	PFM	PLM	POM	PPM	PRM	PTM	SFM	SLM	SOM	SPM	SRM	STM	UHM
4-40 X 1/4	100	4C25XXX	PFM	PLM	POM	PPM	PRM	---	SFM	SLM	SOM	SPM	SRM	STM	UHM
4-40 X 3/8	100	4C37XXX	PFM	PLM	POM	PPM	PRM	---	SFM	SLM	SOM	SPM	SRM	STM	UHM
4-40 X 1/2	100	4C50XXX	PFM	PLM	POM	PPM	PRM	---	SFM	SLM	SOM	SPM	SRM	STM	UHM
4-40 X 5/8	100	4C62XXX	PFM	PLM	POM	PPM	PRM	---	SFM	SLM	SOM	SPM	SRM	STM	---
4-40 X 3/4	100	4C75XXX	PFM	PLM	POM	PPM	PRM	---	SFM	SLM	SOM	SPM	SRM	STM	UHM
4-40 X 1	100	4C100XXX	PFM	PLM	POM	PPM	PRM	---	SFM	SLM	SOM	SPM	SRM	STM	UHM
5-40 X 1/4	100	5C25XXX	PFM	---	POM	PPM	---	---	SFM	---	SOM	SPM	SRM	STM	---
5-40 X 5/16	100	5C31XXX	PFM	---	---	PPM	---	---	SFM	---	---	SPM	SRM	STM	---
5-40 X 3/8	100	5C37XXX	PFM	---	---	PPM	---	---	SFM	---	---	SPM	SRM	STM	---
5-40 X 1/2	100	5C50XXX	PFM	---	---	PPM	---	---	SFM	---	---	SPM	SRM	STM	---
5-40 X 5/8	100	5C62XXX	PFM	---	---	PPM	---	---	SFM	---	---	SPM	SRM	STM	---
5-40 X 3/4	100	5C75XXX	---	---	---	PPM	---	---	SFM	---	---	SPM	SRM	STM	---
6-32 X 1/8	100	6C12XXX	PFM	---	---	PPM	---	---	---	---	---	SPM	SRM	STM	---
6-32 X 3/16	100	6C18XXX	PFM	---	---	PPM	---	---	SFM	---	---	SPM	SRM	STM	---
6-32 X 1/4	100	6C25XXX	PFM	PLM	---	PPM	---	---	SFM	SLM	---	SPM	SRM	STM	UHM
6-32 X 5/16	100	6C31XXX	PFM	PLM	---	PPM	PRM	---	SFM	SLM	---	SPM	SRM	STM	UHM
6-32 X 3/8	100	6C37XXX	PFM	PLM	POM	PPM	PRM	---	SFM	SLM	SOM	SPM	SRM	STM	UHM
6-32 X 7/16	100	6C43XXX	PFM	---	---	PPM	PRM	---	SFM	---	---	SPM	SRM	STM	---
6-32 X 1/2	100	6C50XXX	PFM	PLM	POM	PPM	PRM	PTM	SFM	SLM	SOM	SPM	SRM	STM	UHM
6-32 X 5/8	100	6C62XXX	PFM	---	POM	PPM	PRM	PTM	SFM	---	SOM	SPM	SRM	STM	---
6-32 X 3/4	100	6C75XXX	PFM	PLM	POM	PPM	PRM	PTM	SFM	SLM	SOM	SPM	SRM	STM	UHM
6-32 X 7/8	100	6C87XXX	PFM	---	POM	PPM	PRM	---	SFM	---	SOM	SPM	SRM	STM	---
6-32 X 1	100	6C100XXX	PFM	PLM	POM	PPM	PRM	PTM	SFM	SLM	SOM	SPM	SRM	STM	---
6-32 X 1 1/4	100	6C125XXX	PFM	PLM	POM	PPM	PRM	---	SFM	SLM	SOM	SPM	SRM	STM	UHM
6-32 X 1 1/2	100	6C150XXX	PFM	---	---	PPM	PRM	---	SFM	---	---	SPM	SRM	STM	---
6-32 X 1 3/4	100	6C175XXX	PFM	---	---	PPM	PRM	---	SFM	---	---	SPM	SRM	STM	---
6-32 X 2	100	6C200XXX	PFM	---	---	PPM	PRM	---	SFM	---	---	SPM	SRM	STM	---
6-32 X 2 1/4	100	6C225XXX	PFM	---	---	PPM	---	---	SFM	---	---	SPM	SRM	STM	---
6-32 X 2 1/2	100	6C250XXX	PFM	---	---	PPM	---	---	SFM	---	---	SPM	SRM	STM	---
6-32 X 3	100	6C300XXX	PFM	---	---	PPM	---	---	SFM	---	---	SPM	SRM	STM	---
6-32 X 4	100	6C400XXX	PFM	---	---	PPM	---	---	SFM	---	---	SPM	SRM	STM	---
8-32 X 1/4	100	8C25XXX	PFM	PLM	POM	PPM	PRM	---	SFM	SLM	SOM	SPM	SRM	STM	UHM
8-32 X 5/16	100	8C31XXX	PFM	---	---	PPM	---	---	SFM	---	---	SPM	SRM	STM	---
8-32 X 3/8	100	8C37XXX	PFM	PLM	POM	PPM	PRM	---	SFM	SLM	SOM	SPM	SRM	STM	UHM
8-32 X 1/2	100	8C50XXX	PFM	PLM	POM	PPM	PRM	---	SFM	SLM	SOM	SPM	SRM	STM	UHM
8-32 X 5/8	100	8C62XXX	PFM	PLM	POM	PPM	PRM	---	SFM	SLM	SOM	SPM	SRM	STM	---
8-32 X 3/4	100	8C75XXX	PFM	PLM	POM	PPM	PRM	---	SFM	SLM	SOM	SPM	SRM	STM	UHM
8-32 X 7/8	100	8C87XXX	PFM	---	POM	PPM	PRM	---	SFM	---	SOM	SPM	SRM	STM	---
8-32 X 1	100	8C100XXX	PFM	PLM	POM	PPM	PRM	---	SFM	SLM	SOM	SPM	SRM	STM	UHM
8-32 X 1 1/4	100	8C125XXX	PFM	PLM	POM	PPM	PRM	---	SFM	SLM	SOM	SPM	SRM	STM	UHM
8-32 X 1 1/2	100	8C150XXX	PFM	PLM	POM	PPM	PRM	---	SFM	SLM	SOM	SPM	SRM	STM	UHM
8-32 X 1 3/4	100	8C175XXX	PFM	---	---	PPM	PRM	---	SFM	---	---	SPM	SRM	STM	---
8-32 X 2	100	8C200XXX	PFM	PLM	---	PPM	PRM	---	SFM	SLM	---	SPM	SRM	STM	---
8-32 X 2 1/4	100	8C225XXX	---	---	---	PPM	PRM	---	SFM	---	---	SPM	SRM	STM	---

# MACHINE SCREWS

Size	Pkg Qty	PART#	PFM	PLM	POM	PPM	PRM	PTM	SFM	SLM	SOM	SPM	SRM	STM	UHM
8-32 X 2 1/2	100	8C250XXX	PFM	---	---	PPM	PRM	---	SFM	---	---	SPM	SRM	STM	---
8-32 X 2 3/4	100	8C275XXX	PFM	---	---	PPM	---	---	SFM	---	---	SPM	SRM	STM	---
8-32 X 3	100	8C300XXX	PFM	---	---	PPM	---	---	SFM	---	---	SPM	SRM	STM	---
8-32 X 3 1/2	100	8C350XXX	PFM	---	---	PPM	---	---	SFM	---	---	SPM	SRM	STM	---
8-32 X 4	100	8C400XXX	PFM	---	---	PPM	---	---	SFM	---	---	SPM	SRM	STM	---
10-24 X 1/4	100	10C25XXX	PFM	---	POM	PPM	PRM	---	SFM	---	SOM	SPM	SRM	STM	UHM
10-24 X 5/16	100	10C31XXX	PFM	---	---	PPM	---	---	SFM	---	---	SPM	SRM	STM	UHM
10-24 X 3/8	100	10C37XXX	PFM	PLM	POM	PPM	PRM	---	SFM	SLM	SOM	SPM	SRM	STM	UHM
10-24 X 7/16	100	10C43XXX	PFM	PLM	POM	PPM	---	---	SFM	---	SOM	SPM	SRM	STM	UHM
10-24 X 1/2	100	10C50XXX	PFM	PLM	POM	PPM	PRM	---	SFM	SLM	SOM	SPM	SRM	STM	UHM
10-24 X 5/8	100	10C62XXX	PFM	PLM	POM	PPM	---	---	SFM	SLM	SOM	SPM	SRM	STM	---
10-24 X 3/4	100	10C75XXX	PFM	PLM	POM	PPM	PRM	---	SFM	SLM	SOM	SPM	SRM	STM	UHM
10-24 X 7/8	100	10C87XXX	PFM	---	POM	PPM	---	---	SFM	---	SOM	SPM	SRM	STM	---
10-24 X 1	100	10C100XXX	PFM	PLM	POM	PPM	PRM	PTM	SFM	SLM	SOM	SPM	SRM	STM	UHM
10-24 X 1 1/4	100	10C125XXX	PFM	PLM	POM	PPM	PRM	---	SFM	SLM	SOM	SPM	SRM	STM	HM
10-24 X 1 1/2	100	10C150XXX	PFM	PLM	POM	PPM	PRM	---	SFM	SLM	SOM	SPM	SRM	STM	UHM
10-24 X 1 3/4	100	10C175XXX	PFM	---	---	PPM	PRM	---	SFM	---	---	SPM	SRM	STM	---
10-24 X 2	100	10C200XXX	PFM	PLM	POM	PPM	PRM	---	SFM	SLM	SOM	SPM	SRM	STM	---
10-24 X 2 1/2	100	10C250XXX	PFM	---	---	PPM	PRM	---	SFM	---	---	SPM	SRM	STM	---
10-24 X 3	100	10C300XXX	PFM	---	POM	PPM	PRM	---	SFM	---	SOM	SPM	SRM	STM	---
10-24 X 3 1/2	100	10C350XXX	PFM	---	---	PPM	PRM	---	SFM	---	---	SPM	SRM	STM	---
10-24 X 4	100	10C400XXX	PFM	---	---	PPM	PRM	---	SFM	---	---	SPM	SRM	STM	---
10-24 X 5	100	10C500XXX	PFM	---	---	PPM	PRM	---	SFM	---	---	SPM	SRM	STM	---
10-24 X 6	100	10C600XXX	PFM	---	---	PPM	PRM	---	SFM	---	---	SPM	SRM	STM	---
10-32 X 1/4	100	10F25XXX	PFM	---	---	PPM	PRM	---	SFM	---	---	SPM	SRM	STM	UHM
10-32 X 5/16	100	10F31XXX	PFM	---	---	PPM	---	---	SFM	---	---	SPM	SRM	STM	UHM
10-32 X 3/8	100	10F37XXX	PFM	PLM	POM	PPM	PRM	---	SFM	SLM	SOM	SPM	SRM	STM	UHM
10-32 X 1/2	100	10F50XXX	PFM	PLM	POM	PPM	PRM	---	SFM	SLM	SOM	SPM	SRM	STM	UHM
10-32 X 5/8	100	10F62XXX	PFM	PLM	POM	PPM	---	---	SFM	SLM	SOM	SPM	SRM	STM	---
10-32 X 3/4	100	10F75XXX	PFM	PLM	POM	PPM	PRM	---	SFM	SLM	SOM	SPM	SRM	STM	UHM
10-32 X 7/8	100	10F87XXX	PFM	PLM	POM	PPM	---	---	SFM	SLM	SOM	SPM	SRM	STM	---
10-32 X 1	100	10F100XXX	PFM	PLM	POM	PPM	PRM	---	SFM	SLM	SOM	SPM	SRM	STM	UHM
10-32 X 1 1/4	100	10F125XXX	PMF	PLM	POM	PPM	PRM	---	SFM	SLM	SOM	SPM	SRM	STM	UHM
10-32 X 1 1/2	100	10F150XXX	PMF	PLM	POM	PPM	PRM	---	SFM	SLM	SOM	SPM	SRM	STM	UHM
10-32 X 1 3/4	100	10F175XXX	PFM	---	POM	PPM	PRM	---	SFM	---	SOM	SPM	SRM	STM	---
10-32 X 2	100	10F200XXX	PFM	PLM	POM	PPM	PRM	---	SFM	SLM	SOM	SPM	SRM	STM	---
10-32 X 2 1/2	100	10F250XXX	PFM	---	---	PPM	PRM	---	SFM	---	---	SPM	SRM	STM	---
10-32 X 3	100	10F300XXX	PFM	---	---	PPM	PRM	---	SFM	---	---	SPM	SRM	STM	---
10-32 X 3 1/2	100	10F350XXX	PFM	---	---	PPM	---	---	SFM	---	---	SPM	SRM	STM	---
10-32 X 4	100	10F400XXX	PFM	---	---	PPM	---	---	SFM	---	---	SPM	SRM	STM	---
10-32 X 5	100	10F500XXX	PFM	---	---	PPM	---	---	SFM	---	---	SPM	SRM	STM	---
10-32 X 6	100	10F600XXX	PFM	---	---	PPM	---	---	SFM	---	---	SPM	SRM	STM	---
12-24 X 1/4	100	12C25XXX	PFM	---	---	PPM	---	---	SFM	---	---	SPM	SRM	STM	---
12-24 X 3/8	100	12C37XXX	PFM	---	---	PPM	---	---	SFM	SLM	---	SPM	SRM	STM	UHM
12-24 X 1/2	100	12C50XXX	PFM	---	POM	PPM	PRM	---	SFM	SLM	SOM	SPM	SRM	STM	UHM

# MACHINE SCREWS

Size	Pkg Qty	PART#	PFM	PLM	POM	PPM	PRM	PTM	SFM	SLM	SOM	SPM	SRM	STM	UHM
12-24 x 3/4	100	12C75XXX	PFM	PLM	POM	PPM	PRM	---	SFM	SLM	SOM	SPM	SRM	STM	UHM
12-24 x 7/8	100	12C87XXX	PFM	---	---	PPM	---	---	SFM	---	---	SPM	SRM	STM	---
12-24 x 1	100	12C100XXX	PFM	PLM	POM	PPM	PRM	---	SFM	SLM	SOM	SPM	SRM	STM	UHM
12-24 x 1 1/4	100	12C125XXX	PFM	PLM	POM	PPM	PRM	---	SFM	SLM	SOM	SPM	SRM	STM	---
12-24 x 1 1/2	100	12C150XXX	PFM	PLM	---	PPM	PRM	---	SFM	SLM	---	SPM	SRM	STM	UHM
12-24 x 1 3/4	100	12C175XXX	PFM	---	---	PPM	---	---	SFM	---	---	SPM	SRM	---	---
12-24 x 2	100	12C200XXX	PFM	---	---	PPM	PRM	---	SFM	---	---	SPM	SRM	STM	---
12-24 x 2 1/2	100	12C250XXX	PFM	---	---	PPM	PRM	---	SFM	---	---	SPM	SRM	STM	---
12-24 x 3	100	12C300XXX	PFM	---	---	PPM	PRM	---	SFM	---	---	SPM	SRM	STM	---
1/4-20 x 1/4	100	25C25XXX	---	---	---	PPM	---	---	SFM	---	---	SPM	SRM	STM	---
1/4-20 x 5/16	100	25C31XXX	PFM	---	---	PPM	---	---	SFM	---	---	SPM	SRM	STM	---
1/4-20 x 3/8	100	25C37XXX	PFM	---	---	PPM	PRM	---	---	---	---	SPM	SRM	STM	---
1/4-20 x 1/2	100	25C50XXX	PFM	PLM	POM	PPM	PRM	---	SFM	SLM	SOM	SPM	SRM	STM	---
1/4-20 x 5/8	100	25C62XXX	PFM	---	POM	PPM	PRM	---	SFM	---	SOM	SPM	SRM	STM	---
1/4-20 x 3/4	100	25C75XXX	PFM	PLM	POM	PPM	PRM	---	---	SLM	SOM	SPM	SRM	STM	---
1/4-20 x 7/8	100	25C87XXX	PFM	---	---	PPM	---	---	SFM	---	---	SPM	SRM	STM	---
1/4-20 x 1	100	25C100XXX	PFM	PLM	POM	PPM	PRM	---	SFM	SLM	SOM	SPM	SRM	STM	---
1/4-20 x 1 1/4	100	25C125XXX	PFM	PLM	POM	PPM	PRM	---	SFM	SLM	SOM	SPM	SRM	STM	---
1/4-20 x 1 1/2	100	25C150XXX	PFM	PLM	POM	PPM	PRM	PTM	SFM	SLM	SOM	SPM	SRM	STM	---
1/4-20 x 1 3/4	100	25C175XXX	PFM	---	---	PPM	PRM	---	---	---	---	SPM	SRM	STM	---
1/4-20 x 2	100	25C200XXX	PFM	PLM	POM	PPM	PRM	PTM	SFM	SLM	SOM	SPM	SRM	STM	---
1/4-20 x 2 1/4	100	25C225XXX	PFM	---	---	PPM	---	---	SFM	---	---	SPM	SRM	STM	---
1/4-20 x 2 1/2	100	25C250XXX	PFM	---	POM	PPM	PRM	---	SFM	---	SOM	SPM	SRM	STM	---
1/4-20 x 3	100	25C300XXX	PFM	---	---	PPM	PRM	---	SFM	---	---	SPM	SRM	STM	---
1/4-20 x 3 1/2	100	25C350XXX	PFM	---	---	PPM	PRM	---	---	---	---	SPM	SRM	STM	---
1/4-20 x 4	100	25C400XXX	PFM	---	---	PPM	PRM	---	SFM	---	---	SPM	SRM	STM	---
1/4-20 x 5	100	25C500XXX	PFM	---	---	PPM	PRM	---	SFM	---	---	SPM	SRM	STM	---
1/4-20 x 6	100	25C600XXX	PFM	---	---	PPM	PRM	---	SFM	---	---	SPM	SRM	STM	---
5/16-18 x 1/2	100	31C50XXX	PFM	PLM	---	PPM	PRM	---	SFM	SLM	---	SPM	SRM	STM	UHM
5/16-18 x 5/8	100	31X62XXX	PFM	PLM	---	PPM	---	---	---	SLM	---	SPM	SRM	STM	---
5/16-18 x 3/4	100	31C75XXX	PFM	PLM	POM	PPM	PRM	---	SFM	SLM	SOM	SPM	SRM	STM	---
5/16-18 x 7/8	100	31C87XXX	PFM	---	---	PPM	---	---	SFM	---	SOM	SPM	SRM	STM	---
5/16-18 x 1	100	31C100XXX	PMF	PLM	POM	PPM	PRM	---	SFM	SLM	---	SPM	SRM	STM	---
5/16-18 x 1 1/4	100	31C125XXX	PMF	PLM	---	PPM	PRM	---	SFM	SLM	SOM	SPM	SRM	STM	---
5/16-18 x 1 1/2	100	31C150XXX	PFM	PLM	POM	PPM	PRM	---	---	SLM	---	SPM	SRM	STM	---
5/16-18 x 1 3/4	100	31C175XXX	PFM	---	---	PPM	---	---	SFM	---	---	SPM	SRM	STM	---
5/16-18 x 2	100	31C200XXX	PFM	PLM	---	PPM	PRM	---	SFM	SLM	---	SPM	SRM	STM	---
5/16-18 x 2 1/2	100	31C250XXX	PFM	---	---	PPM	PRM	---	SFM	---	---	SPM	SRM	STM	---
5/16-18 x 3	100	31C300XXX	PFM	---	---	PPM	PRM	---	SFM	---	---	SPM	SRM	STM	---
5/16-18 x 3 1/2	100	31C350XXX	PFM	---	---	PPM	PRM	---	---	---	---	SPM	SRM	STM	---
5/16-18 x 4	100	31C400XXX	PFM	---	---	PPM	PRM	---	SFM	---	---	SPM	SRM	STM	---
5/16-18 x 5	100	31C500XXX	PFM	---	---	PPM	PRM	---	SFM	---	---	SPM	SRM	STM	---
5/16-18 x 6	100	31C600XXX	PFM	---	---	PPM	PRM	---	---	---	---	SPM	SRM	STM	---

OTHER SIZES AVAILABLE UPON REQUEST

UNLIMITED SUPPLIES



# TAPPING SCREW HEAD STYLES



PFT  
PHILLIPS FLAT



SFT  
SLOTTED FLAT



POT  
PHILLIPS OVAL



SOT  
SLOTTED OVAL



PPT  
PHILLIPS PAN



SPT  
SLOTTED PAN



PTT  
PHILLIPS TRUSS



STT  
SLOTTED TRUSS



SHT  
SLOTTED HEX

## TAPPING SCREWS

Size	Pkg Qty	PART#	PFT	POT	PPT	PTT	SFT	SHT	SOT	SPT	STT
2 X 3/16	100	2X18XXX	---	---	---	---	---	---	---	SPT	---
2 X 1/4	100	2X25XXX	---	---	---	---	---	---	---	SPT	---
2 X 3/8	100	2X37XXX	---	---	---	---	---	---	---	SPT	---
2 X 1/2	100	2X50XXX	---	---	---	---	---	---	---	SPT	---
2 X 3/4	100	2X75XXX	---	---	---	---	---	---	---	SPT	---
4 X 1/4	100	4X25XXX	---	---	PPT	---	SFT	SHT	---	SPT	STT
4 X 3/8	100	4X37XXX	PFT	---	PPT	PTT	SFT	SHT	SOT	SPT	STT
4 X 1/2	100	4X50XXX	PFT	POT	PPT	---	SFT	SHT	SOT	SPT	STT
4 X 5/8	100	4X62XXX	PFT	POT	PPT	---	SFT	SHT	SOT	SPT	STT
4 X 3/4	100	4X75XXX	PFT	POT	PPT	---	SFT	SHT	SOT	SPT	STT
4 X 7/8	100	4X87XXX	---	---	---	---	SFT	---	---	SPT	---
4 X 1	100	4X100XXX	---	---	---	---	SFT	SHT	SOT	SPT	---
4 X 1 1/4	100	4X125XXX	---	---	---	---	---	---	SOT	SPT	---
6 X 1/4	100	6X25XXX	PFT	---	PPT	PTT	SFT	SHT	SOT	SPT	STT
6 X 3/8	100	6X37XXX	PFT	POT	PPT	PTT	SFT	SHT	SOT	SPT	STT
6 X 1/2	100	6X50XXX	PFT	POT	PPT	PTT	SFT	SHT	SOT	SPT	STT
6 X 5/8	100	6X62XXX	PFT	POT	PPT	PTT	SFT	SHT	SOT	SPT	STT
6 X 3/4	100	6X75XXX	PFT	POT	PPT	PTT	SFT	SHT	SOT	SPT	STT
6 X 7/8	100	6X87XXX	PFT	POT	PPT	---	SFT	SHT	SOT	SPT	STT
6 X 1	100	6X100XXX	PFT	POT	PPT	PTT	SFT	SHT	SOT	SPT	STT
6 X 1 1/4	100	6X125XXX	PFT	POT	PPT	---	SFT	SHT	SOT	SPT	STT
6 X 1 1/2	100	6X150XXX	PFT	POT	PPT	---	SFT	SHT	SOT	SPT	STT
6 X 1 3/4	100	6X175XXX	---	---	---	---	---	---	---	SPT	---
6 X 2	100	6X200XXX	---	---	---	---	---	---	---	SPT	---
7 X 1/4	100	7X25XXX	---	---	---	---	---	---	---	SPT	---
7 X 3/8	100	7X37XXX	---	POT	PPT	---	SFT	---	---	SPT	STT
7 X 1/2	100	7X50XXX	PFT	POT	PPT	---	SFT	SHT	---	SPT	STT
7 X 5/8	100	7X62XXX	---	---	PPT	---	SFT	---	---	SPT	STT
7 X 3/4	100	7X75XXX	---	---	PPT	---	SFT	SHT	---	SPT	STT
7 X 7/8	100	7X87XXX	---	---	---	---	SFT	---	SOT	SPT	STT
7 X 1	100	7X100XXX	---	---	PPT	---	SFT	SHT	---	SPT	STT
7 X 1 1/4	100	7X125XXX	---	---	---	---	SFT	---	---	SPT	---
7 X 1 1/2	100	7X150XXX	---	---	PPT	---	---	---	---	SPT	---
8 X 1/4	100	8X25XXX	---	---	PPT	---	SFT	SHT	---	SPT	STT
8 X 3/8	100	8X37XXX	PFT	POT	PPT	PTT	SFT	SHT	SOT	SPT	STT
8 X 1/2	100	8X50XXX	PFT	POT	PPT	PTT	SFT	SHT	SOT	SPT	STT
8 X 5/8	100	8X62XXX	PFT	POT	PPT	PTT	SFT	SHT	SOT	SPT	STT
8 X 3/4	100	8X75XXX	PFT	POT	PPT	PTT	SFT	SHT	SOT	SPT	STT
8 X 7/8	100	8X87XXX	PFT	POT	PPT	---	SFT	SHT	SOT	SPT	STT
8 X 1	100	8X100XXX	PFT	POT	PPT	PTT	SFT	SHT	SOT	SPT	STT

OTHER SIZES AVAILABLE UPON REQUEST

UNLIMITED SUPPLIES

## TAPPING SCREWS

Size	Pkg Qty	PART#	PFT	POT	PPT	PTT	SFT	SHT	SOT	SPT	STT
8 X 1 1/4	100	8X125XXX	PFT	POT	PPT	---	SFT	SHT	SOT	SPT	STT
8 X 1 1/2	100	8X150XXX	PFT	POT	PPT	---	SFT	SHT	SOT	SPT	STT
8 X 1 3/4	100	8X175XXX	PFT	POT	PPT	---	SFT	---	SOT	SPT	---
8 X 2	100	8X200XXX	PFT	POT	PPT	---	SFT	SHT	SOT	SPT	---
8 X 2 1/2	100	8X250XXX	PFT	---	PPT	---	SFT	---	---	SPT	---
8 X 3	100	8X300XXX	PFT	---	PPT	---	SFT	---	---	SPT	---
10 X 3/8	100	10X37XXX	---	POT	PPT	---	SFT	SHT	SOT	SPT	STT
10 X 1/2	100	10X50XXX	PFT	POT	PPT	PTT	SFT	SHT	SOT	SPT	STT
10 X 5/8	100	10X62XXX	PFT	POT	PPT	PTT	SFT	SHT	SOT	SPT	---
10 X 3/4	100	10X75XXX	PFT	POT	PPT	PTT	SFT	SHT	SOT	SPT	STT
10 X 7/8	100	10X87XXX	PFT	POT	PPT	PTT	SFT	SHT	SOT	SPT	STT
10 X 1	100	10X100XXX	PFT	POT	PPT	---	SFT	SHT	SOT	SPT	STT
10 X 1 1/4	100	10X125XXX	PFT	POT	PPT	---	SFT	SHT	SOT	SPT	STT
10 X 1 1/2	100	10X150XXX	PFT	POT	PPT	---	SFT	SHT	SOT	SPT	---
10 X 1 3/4	100	10X175XXX	PFT	POT	PPT	---	SFT	SHT	SOT	SPT	STT
10 X 2	100	10X200XXX	PFT	POT	PPT	---	SFT	SHT	SOT	SPT	---
10 X 2 1/2	100	10X250XXX	PFT	---	PPT	---	SFT	SHT	---	SPT	---
10 X 3	100	10X300XXX	PFT	---	PPT	---	SFT	SHT	---	SPT	---
12 X 3/8	100	12X37XXX	---	---	PPT	---	SFT	SHT	SOT	SPT	STT
12 X 1/2	100	12X50XXX	PFT	POT	PPT	PTT	SFT	SHT	SOT	SPT	STT
12 X 5/8	100	12X62XXX	PFT	POT	PPT	PTT	SFT	SHT	SOT	SPT	STT
12 X 3/4	100	12X75XXX	PFT	POT	PPT	PTT	SFT	SHT	SOT	SPT	STT
12 X 7/8	100	12X87XXX	---	POT	PPT	---	SFT	SHT	SOT	SPT	STT
12 X 1	100	12X100XXX	PFT	POT	PPT	---	SFT	SHT	SOT	SPT	STT
12 X 1 1/4	100	12X125XXX	PFT	POT	PPT	---	SFT	SHT	SOT	SPT	STT
12 X 1 1/2	100	12X150XXX	PFT	POT	PPT	---	SFT	SHT	SOT	SPT	STT
12 X 1 3/4	50	12X175XXX	PFT	POT	PPT	---	SFT	SHT	SOT	SPT	---
12 X 2	50	12X200XXX	PFT	POT	PPT	---	SFT	SHT	SOT	SPT	STT
12 X 2 1/2	50	12X250XXX	PFT	---	PPT	---	SFT	SHT	---	SPT	---
12 X 3	50	12X300XXX	PFT	---	PPT	---	SFT	SHT	---	SPT	---
14 X 1/2	100	14X50XXX	---	---	PPT	---	SFT	SHT	SOT	SPT	STT
14 X 5/8	100	14X62XXX	PFT	POT	PPT	PTT	SFT	SHT	SOT	SPT	---
14 X 3/4	100	14X75XXX	PFT	POT	PPT	PTT	SFT	SHT	SOT	SPT	---
14 X 1	100	14X100XXX	PFT	POT	PPT	---	SFT	SHT	SOT	SPT	---
14 X 1 1/4	100	14X125XXX	PFT	POT	PPT	---	SFT	SHT	SOT	SPT	---
14 X 1 1/2	100	14X150XXX	PFT	POT	PPT	---	SFT	SHT	SOT	SPT	---
14 X 1 3/4	50	14X175XXX	PFT	---	PPT	---	SFT	SHT	SOT	SPT	---
14 X 2	50	14X200XXX	PFT	---	PPT	---	SFT	SHT	SOT	SPT	---
14 X 2 1/2	50	14X250XXX	PFT	---	PPT	---	SFT	SHT	---	SPT	---
14 X 3	50	14X300XXX	PFT	---	PPT	---	SFT	SHT	---	SPT	---
14 X 3 1/2	50	14X350XXX	PFT	---	PPT	---	SFT	---	---	SPT	---

## SELF THREADING SCREWS



### TORX DRIVE FLAT HEAD TYPE "F" FLOOR BOARD SCREWS



Size	Pkg Qty	PART#
1/4-20 X 1 1/2	100	25C150TFF
1/4-20 X 1 3/4	100	25C175TFF
1/4-20 X 2	100	25C200TFF
1/4-20 X 2 1/4	100	25C225TFF
1/4-20 X 2 1/2	100	25C250TFF
1/4-20 X 3	100	25C300TFF
1/4-20 X 4	100	25C400TFF
5/16-18 X 1 3/4	100	31C175TFF
5/16-18 X 2	100	31C200TFF
5/16-18 X 2 1/2	50	31C250TFF
1/4" - #T30		
5/16" - #T40		

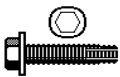

### UNSLOTTED HEX TYPE "F"

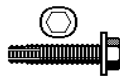

Size	Pkg Qty	PART#
10-24 X 1/2	100	10C50UHF
10-24 X 3/4	100	10C75UHF
10-24 X 1	100	10C100UHF
10-24 X 1 1/4	100	10C125UHF
10-24 X 1 1/2	100	10C150UHF
1/4-20 X 1/2	100	25C50UHF
1/4-20 X 3/4	100	25C75UHF
1/4-20 X 1	100	25C100UHF
1/4-20 X 1 1/4	100	25C125UHF
1/4-20 X 1 1/2	100	25C150UHF
5/16-18 X 1/2	100	31C50UHF
5/16-18 X 3/4	100	31C75UHF
5/16-18 X 1	50	31C100UHF
3/8-16 X 3/4	50	37C75UHF
3/8-16 X 1	50	37C100UHF
3/8-16 X 1 1/4	50	37C125UHF
3/8-16 X 1 1/2	50	37C150UHF

## SELF DRILLING SCREWS

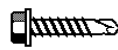

### UNSLOTTED HEX TEK SCREWS

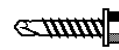

Size	Pkg Qty	PART#
6 X 1/2	100	6X50UHK
6 X 3/4	100	6X75UHK
6 X 1	100	6X100UHK
8 X 1/2	100	8X50UHK
8 X 3/4	100	8X75UHK
8 X 1	100	8X100UHK
8 X 1 1/4	100	8X125UHK
8 X 1 1/2	100	8X150UHK
10 X 1/2	100	10X50UHK
10 X 5/8	100	10X62UHK
10 X 3/4	100	10X75UHK
10 X 1	100	10X100UHK
10 X 1 1/4	100	10X125UHK
10 X 1 1/2	100	10X150UHK
10 X 2	100	10X200UHK
12 X 3/4	100	12X75UHK
12 X 1	100	12X100UHK
12 X 1 1/4	100	12X125UHK
12 X 1 1/2	100	12X150UHK
12 X 2	100	12X200UHK
14 X 3/4	100	14X75UHK
14 X 1	100	14X100UHK
14 X 1 1/4	100	14X125UHK
14 X 1 1/2	100	14X150UHK
14 X 2	50	14X200UHK

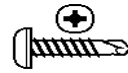

### PHILLIPS PAN TEK SCREW



Size	Pkg Qty	PART#
6 X 3/8	100	6X37PPK
6 X 1/2	100	6X50PPK
6 X 3/4	100	6X75PPK
6 X 1	100	6X100PPK
8 X 1/2	100	8X50PPK
8 X 5/8	100	8X62PPK
8 X 3/4	100	8X75PPK
8 X 1	100	8X100PPK
8 X 1 1/2	100	8X150PPK
10 X 1/2	100	10X50PPK
10 X 5/8	100	10X62PPK
10 X 3/4	100	10X75PPK
10 X 1	100	10X100PPK

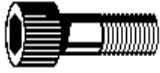

# SOCKET HEAD CAP SCREWS



## HEAT TREATED ALLOY STEEL UNIFIED 3A THREAD FIT

Size	Pkg Qty	4-40	
4 X 3/16	100	4C18SHC	----
4 X 1/4	100	4C25SHC	----
4 X 5/16	100	4C31SHC	----
4 X 3/8	100	4C37SHC	----
4 X 1/2	100	4C50SHC	----
4 X 5/8	100	4C62SHC	----
4 X 3/4	100	4C75SHC	----
4 X 7/8	100	4C87SHC	----
4 X 1	100	4C100SHC	----

3/32" KEY

Size	Pkg Qty	6-32	6-40
6 X 1/4	100	6C25SHC	6F25SHC
6 X 3/8	100	6C37SHC	6F37SHC
6 X 1/2	100	6C50SHC	6F50SHC
6 X 5/8	100	6C62SHC	6F62SHC
6 X 3/4	100	6C75SHC	6F75SHC
6 X 7/8	100	6C87SHC	6F87SHC
6 X 1	100	6C100SHC	6F100SHC
6 X 1 1/4	100	6C125SHC	6F125SHC
6 X 1 1/2	100	6C150SHC	6F150SHC
6 X 1 3/4	100	6C175SHC	6F175SHC
6 X 2	100	6C200SHC	6F200SHC

7/64" KEY

Size	Pkg Qty	8-32	8-36
8 X 1/4	100	8C25SHC	----
8 X 3/8	100	8C37SHC	8F37SHC
8 X 1/2	100	8C50SHC	8F50SHC
8 X 5/8	100	8C62SHC	----
8 X 3/4	100	8C75SHC	8F75SHC
8 X 7/8	100	8C87SHC	----
8 X 1	100	8C100SHC	----
8 X 1 1/4	100	8C125SHC	----
8 X 1 1/2	100	8C150SHC	----
8 X 1 3/4	100	8C175SHC	----
8 X 2	100	8C200SHC	----
8 X 2 1/2	100	8C250SHC	----

9/64" KEY

Size	Pkg Qty	10-24	10-32
10 X 1/4	100	10C25SHC	10F25SHC
10 X 3/8	100	10C37SHC	10F37SHC
10 X 1/2	100	10C50SHC	10F50SHC
10 X 5/8	100	10C62SHC	10F62SHC
10 X 3/4	100	10C75SHC	10F75SHC
10 X 7/8	100	10C87SHC	10F87SHC
10 X 1	100	10C100SHC	10F100SHC
10 X 1 1/4	100	10C125SHC	10F125SHC
10 X 1 1/2	100	10C150SHC	10F150SHC
10 X 1 3/4	100	10C175SHC	10F175SHC
10 X 2	100	10C200SHC	10F200SHC
10 X 2 1/4	100	10C225SHC	10F225SHC
10 X 2 1/2	100	10C250SHC	10F250SHC
10 X 3	100	10C300SHC	10F300SHC

5/32" KEY

UNLIMITED SUPPLIES

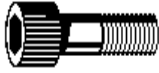

# SOCKET HEAD CAP SCREWS



Size	Pkg Qty	UNC 1/4-20	UNF 1/4-28
1/4 X 1/4	100	25C25SHC	25F25SHC
1/4 X 3/8	100	25C37SHC	25F37SHC
1/4 X 1/2	100	25C50SHC	25F50SHC
1/4 X 5/8	100	25C62SHC	25F62SHC
1/4 X 3/4	100	25C75SHC	25F75SHC
1/4 X 7/8	100	25C87SHC	25F87SHC
1/4 X 1	100	25C100SHC	25F100SHC
1/4 X 1 1/4	100	25C125SHC	25F125SHC
1/4 X 1 1/2	100	25C150SHC	25F150SHC
1/4 X 1 3/4	50	25C175SHC	25F175SHC
1/4 X 2	50	25C200SHC	25F200SHC
1/4 X 2 1/4	50	25C225SHC	25F225SHC
1/4 X 2 1/2	50	25C250SHC	25F250SHC
1/4 X 2 3/4	50	25C275SHC	25F275SHC
1/4 X 3	50	25C300SHC	25F300SHC
1/4 X 3 1/4	50	25C325SHC	----
1/4 X 3 1/2	50	25C350SHC	----
1/4 X 3 3/4	50	25C375SHC	----
1/4 X 4	50	25C400SHC	25F400SHC

**3/16" KEY**

Size	Pkg Qty	UNC 3/8-16	UNF 3/8-24
3/8 X 1/2	100	37C50SHC	37F50SHC
3/8 X 5/8	100	37C62SHC	37F62SHC
3/8 X 3/4	100	37C75SHC	37F75SHC
3/8 X 7/8	100	37C87SHC	37F87SHC
3/8 X 1	100	37C100SHC	37F100SHC
3/8 X 1 1/4	100	37C125SHC	37F125SHC
3/8 X 1 1/2	100	37C150SHC	37F150SHC
3/8 X 1 3/4	50	37C175SHC	37F175SHC
3/8 X 2	50	37C200SHC	37F200SHC
3/8 X 2 1/4	50	37C225SHC	37F225SHC
3/8 X 2 1/2	50	37C250SHC	37F250SHC
3/8 X 2 3/4	50	37C275SHC	37F275SHC
3/8 X 3	50	37C300SHC	37F300SHC
3/8 X 3 1/4	50	37C325SHC	37F325SHC
3/8 X 3 1/2	50	37C350SHC	37F350SHC
3/8 X 4	50	37C400SHC	37F400SHC
3/8 X 4 1/2	50	37C450SHC	37F450SHC
3/8 X 5	50	37C500SHC	37F500SHC
3/8 X 5 1/2	50	37C550SHC	----
3/8 X 6	50	37C600SHC	----

**5/16" KEY**

Size	Pkg Qty	UNC 5/16-18	UNF 5/16-24
5/16 X 3/8	100	31C37SHC	----
5/16 X 1/2	100	31C50SHC	31F50SHC
5/16 X 5/8	100	31C62SHC	31F62SHC
5/16 X 3/4	100	31C75SHC	31F75SHC
5/16 X 7/8	100	31C87SHC	31F87SHC
5/16 X 1	100	31C100SHC	31F100SHC
5/16 X 1 1/4	100	31C125SHC	31F125SHC
5/16 X 1 1/2	100	31C150SHC	31F150SHC
5/16 X 1 3/4	100	31C175SHC	31F175SHC
5/16 X 2	50	31C200SHC	31F200SHC
5/16 X 2 1/4	50	31C225SHC	31F225SHC
5/16 X 2 1/2	50	31C250SHC	31F250SHC
5/16 X 2 3/4	50	31C275SHC	----
5/16 X 3	50	31C300SHC	----
5/16 X 3 1/4	50	31C325SHC	----
5/16 X 3 1/2	50	31C350SHC	----
5/16 X 4	50	31C400SHC	----

**1/4" KEY**

Size	Pkg Qty	UNC 7/16-14	UNC 7/16-20
7/16 x 1/2	100	43C50SHC	-----
7/16 x 5/8	100	43C62SHC	----
7/16 x 3/4	100	43C75SHC	----
7/16 x 7/8	100	43C87SHC	----
7/16 x 1	100	43C100SHC	43F100SHC
7/16 x 1 1/4	50	43C125SHC	43F125SHC
7/16 x 1 1/2	50	43C150SHC	43F150SHC
7/16 x 1 3/4	50	43C175SHC	----
7/16 x 2	50	43C200SHC	43F200SHC
7/16 x 2 1/4	50	43C225SHC	----
7/16 x 2 1/2	50	43C250SHC	----
7/16 x 2 3/4	25	43C275SHC	----
7/16 x 3	25	43C300SHC	----
7/16 x 3 1/2	25	43C350SHC	----
7/16 x 4	25	43C400HH5	----
7/16 x 4 1/2	25	43C450HH5	----
7/16 x 5	25	43C500HH5	-----

**3/8" KEY**

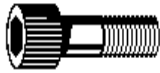

# SOCKET HEAD CAP SCREWS

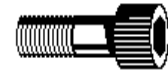

Size	Pkg Qty	UNC 1/2-13	UNF 1/2-20
1/2 X 1/2	50	50C50SHC	----
1/2 X 5/8	50	50C62SHC	----
1/2 X 3/4	50	50C75SHC	----
1/2 X 7/8	50	50C87SHC	----
1/2 X 1	50	50C100SHC	50F100SHC
1/2 X 1 1/4	50	50C125SHC	50F125SHC
1/2 X 1 1/2	50	50C150SHC	50F150SHC
1/2 X 1 3/4	50	50C175SHC	50F175SHC
1/2 X 2	50	50C200SHC	50F200SHC
1/2 X 2 1/4	25	50C225SHC	50F225SHC
1/2 X 2 1/2	25	50C250SHC	50F250SHC
1/2 X 2 3/4	25	50C275SHC	50F275SHC
1/2 X 3	25	50C300SHC	50F300SHC
1/2 X 3 1/4	25	50C325SHC	----
1/2 X 3 1/2	25	50C350SHC	50F350SHC
1/2 X 3 3/4	25	50C375SHC	----
1/2 X 4	25	50C400SHC	50F400SHC
1/2 X 4 1/2	25	50C450SHC	50F450SHC
1/2 X 5	25	50C500SHC	50F500SHC
1/2 X 5 1/2	25	50C550SHC	50F550SHC
1/2 X 6	25	50C600SHC	50F600SHC
1/2 X 6 1/2	10	50C650SHC	----
1/2 X 7	10	50C700SHC	----
1/2 X 8	10	50C800SHC	----

**3/8" KEY**

Size	Pkg Qty	UNC 5/8-11	UNF 5/8-18
5/8 X 1	25	62C100SHC	62F100SHC
5/8 X 1 1/4	25	62C125SHC	62F125SHC
5/8 X 1 1/2	25	62C150SHC	62F150SHC
5/8 X 1 3/4	25	62C175SHC	62F175SHC
5/8 X 2	25	62C200SHC	62F200SHC
5/8 X2 1/4	25	62C225SHC	62F225SHC
5/8 X 2 1/2	25	62C250SHC	62F250SHC
5/8 X 2 3/4	25	62C275SHC	62F275SHC
5/8 X 3	25	62C300SHC	62F300SHC
5/8 X 3 1/4	25	62C325SHC	----
5/8 X 3 1/2	25	62C350SHC	62F350SHC
5/8 X 4	25	62C400SHC	62F400SHC

**1/2" KEY**

Size	Pkg Qty	UNC 5/8-11	UNF 5/8-18
5/8 X 4 1/2	25	62C450SHC	62F450SHC
5/8 X 5	25	62C500SHC	62F500SHC
5/8 X 5 1/2	10	62C550SHC	----
5/8 X 6	10	62C600SHC	----
5/8 X 6 1/2	10	62C650SHC	----
5/8 X 7	10	62C700SHC	----
5/8 X 8	10	62C800SHC	----

**1/2" KEY**

Size	Pkg Qty	3/4-10	3/4-16
3/4 X 1 1/4	25	75C125SHC	----
3/4 X 1 1/2	25	75C150SHC	----
3/4 X 1 3/4	25	75C175SHC	----
3/4 X 2	25	75C200SHC	----
3/4 X 2 1/4	25	75C225SHC	----
3/4 X 2 1/2	25	75C250SHC	----
3/4 X 2 3/4	25	75C275SHC	----
3/4 X 3	25	75C300SHC	----
3/4 X 3 1/4	25	75C325SHC	----
3/4 X 3 1/2	25	75C350SHC	----
3/4 X 3 3/4	25	75C375SHC	----
3/4 X 4	25	75C400SHC	----
3/4 X 4 1/2	25	75C450SHC	----
3/4 X 5	25	75C500SHC	----
3/4 X 5 1/2	10	75C550SHC	----
3/4 X 6	10	75C600SHC	----
3/4 X 6 1/2	10	75C650SHC	----
3/4 X 7	10	75C700SHC	----
3/4 X 8	10	75C800SHC	----

**5/8" KEY**

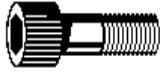

# SOCKET HEAD CAP SCREWS



Size	Pkg Qty	7/8-9	7/8-14
7/8 X 2	10	87C200SHC	----
7/8 X 2 1/4	10	87C225SHC	----
7/8 X 2 1/2	10	87C250SHC	----
7/8 X 2 3/4	10	87C275SHC	----
7/8 X 3	10	87C300SHC	----
7/8 X 3 1/4	10	87C325SHC	----
7/8 X 3 1/2	10	87C350SHC	----
7/8 X 4	10	87C400SHC	----
7/8 X 4 1/2	10	87C450SHC	----
7/8 X 5	10	87C500SHC	----
7/8 X 5 1/2	10	87C550SHC	----
7/8 X 6	10	87C600SHC	----
7/8 X 7	10	87C700SHC	----
7/8 X 8	10	87C800SHC	----

**3/4" KEY**

Size	Pkg Qty	1 1/4-7	1 1/4-12
1 1/4 X 3	1	125C300SHC	----
1 1/4 X 3 1/2	1	125C350SHC	----
1 1/4 X 4	1	125C400SHC	----
1 1/4 X 4 1/2	1	125C450SHC	----
1 1/4 X 5	1	125C500SHC	----
1 1/4 X 5 1/2	1	125C550SHC	----
1 1/4 X 6	1	125C600SHC	----
1 1/4 X 6 1/2	1	125C650SHC	----
1 1/4 X 7	1	125C700SHC	----
1 1/4 X 8	1	125C800SHC	----
1 1/4 X 9	1	125C900SHC	----
1 1/4 X 10	1	125C1000SHC	----

**7/8" KEY**

Size	Pkg Qty	1-8	1-14
1 X 2	10	100C200SHC	----
1 X 2 1/4	10	100C225SHC	----
1 X 2 1/2	10	100C250SHC	----
1 X 2 3/4	10	100C275SHC	----
1 X 3	10	100C300SHC	----
1 X 3 1/4	10	100C325SHC	----
1 X 3 1/2	10	100C350SHC	----
1 X 4	10	100C400SHC	----
1 X 4 1/2	10	100C450SHC	----
1 X 5	10	100C500SHC	----
1 X 5 1/2	10	100C550SHC	----
1 X 6	10	100C600SHC	----
1 X 6 1/2	10	100C650SHC	----
1 X 7	10	100C700SHC	----
1 X 8	10	100C800SHC	----



**3/4" KEY**



Size	Pkg Qty	1 1/2-6	1 1/2-12
1 1/2 X 3 1/2	1	150C350SHC	----
1 1/2 X 4	1	150C400SHC	----
1 1/2 X 4 1/2	1	150C450SHC	----
1 1/2 X 5	1	150C500SHC	----
1 1/2 X 5 1/2	1	150C550SHC	----
1 1/2 X 6	1	150C600SHC	----
1 1/2 X 6 1/2	1	150C650SHC	----
1 1/2 X 7	1	150C700SHC	----
1 1/2 X 8	1	150C800SHC	----



**1" KEY**





# SOCKET HEAD CAP SCREWS ALLOY





 <b>LOW HEAD</b> 		
Size	Pkg Qty	Part#
8-32 x 3/8	100	8C37LSC
8-32 x 1/2	100	8C50LSC
8-32 x 3/4	100	8C75LSC
8-32 x 1	100	8C100LSC
5/64" KEY		
10-24 x 3/8	100	10C37LSC
10-24 x 1/2	100	10C50LSC
10-24 x 5/8	100	10C62LSC
10-24 x 3/4	100	10C75LSC
10-24 x 1	100	10C100LSC
3/32" KEY		
1/4-20 x 3/8	100	25C37LSC
1/4-20 x 1/2	100	25C50LSC
1/4-20 x 5/8	100	25C62LSC
1/4-20 x 3/4	100	25C75LSC
1/4-20 x 1	100	25C100LSC
1/8" KEY		
5/16-18 x 1/2	100	31C50LSC
5/16-18 x 3/4	100	31C75LSC
5/16-18 x 1	100	31C100LSC
5/16-18 x 1 1/4	100	31C125LSC
5/16-18 x 1 1/2	100	31C150LSC
5/32" KEY		
3/8-16 x 1/2	100	37C50LSC
3/8-16 x 3/4	100	37C75LSC
3/8-16 x 1	100	37C100LSC
3/8-16 x 1 1/4	100	37C125LSC
3/8-16 x 1 1/2	100	37C150LSC
3/16" KEY		
1/2-13 x 3/4	50	50C75LSC
1/2-13 x 1	50	50C100LSC
1/2-13 x 1 1/4	50	50C125LSC
1/2-13 x 1 1/2	50	50C150LSC
1/4" KEY		
10-32 X 3/8	100	10F37LSC
10-32 X 1/2	100	10F50LSC
10-32 X 5/8	100	10F62LSC
10-32 X 3/4	100	10F75LSC
3/32" KEY		



 <b>FLAT HEAD</b> 		
Size	Pkg Qty	Part#
4-40 x 1/4	100	4C25FSC
4-40 x 3/8	100	4C37FSC
4-40 x 1/2	100	4C50FSC
4-40 x 5/8	100	4C62FSC
4-40 x 3/4	100	4C75FSC
1/16" KEY		
5-40 x 1/4	100	5C25FSC
5-40 x 3/8	100	5C37FSC
5-40 x 1/2	100	5C50FSC
5-40 x 5/8	100	5C62FSC
5-40 x 3/4	100	5C75FSC
5/64" KEY		
6-32 x 1/4	100	6C25FSC
6-32 x 3/8	100	6C37FSC
6-32 x 1/2	100	6C50FSC
6-32 x 5/8	100	6C62FSC
6-32 x 3/4	100	6C75FSC
5/64" KEY		
8-32 x 3/8	100	8C37FSC
8-32 x 1/2	100	8C50FSC
8-32 x 5/8	100	8C62FSC
8-32 x 3/4	100	8C75FSC
8-32 x 1	100	8C100FSC
3/32" KEY		
10-24 x 3/8	100	10C37FSC
10-24 x 1/2	100	10C50FSC
10-24 x 5/8	100	10C62FSC
10-24 x 3/4	100	10C75FSC
10-24 x 1	100	10C100FSC
10-24 x 1 1/4	100	10C125FSC
10-24 x 1 1/2	100	10C150FSC
1/8" KEY		
10-32 x 3/8	100	10F37FSC
10-32 x 1/2	100	10F50FSC
10-32 x 5/8	100	10F62FSC
10-32 x 3/4	100	10F75FSC
10-32 x 1	100	10F100FSC
10-32 x 1 1/4	100	10F125FSC
10-32 x 1 1/2	100	10F150FSC
1/8" KEY		

 <b>FLAT HEAD</b> 		
Size	Pkg Qty	Part#
1/4-20 x 3/8	100	25C37FSC
1/4-20 x 1/2	100	25C50FSC
1/4-20 x 5/8	100	25C62FSC
1/4-20 x 3/4	100	25C75FSC
1/4-20 x 1	100	25C100FSC
1/4-20 x1 1/4	100	25C125FSC
1/4-20 x 1 1/2	100	25C150FSC
1/4-20 x 1 3/4	100	25C175FSC
1/4-20 x 2	100	25C200FSC
5/32" KEY		
1/4-28 x 3/8	100	25F37FSC
1/4-28 x 1/2	100	25F50FSC
1/4-28 x 5/8	100	25F62FSC
1/4-28 x 3/4	100	25F75FSC
1/4-28 x 1	100	25F100FSC
1/4-28 x 1 1/4	100	25F125FSC
1/4-28 x 1 1/2	100	25F150FSC
5/32" KEY		
5/16-18 x 1/2	100	31C50FSC
5/16-18 x 5/8	100	31C62FSC
5/16-18 x 3/4	100	31C75FSC
5/16-18 x 1	100	31C100FSC
5/16-18 x 1 1/4	100	31C125FSC
5/16-18 x 1 1/2	100	31C150FSC
5/16-18 x 1 3/4	100	31C175FSC
5/16-18 x 2	100	31C200FSC
5/16-18 x 2 1/4	100	31C225FSC
5/16-18 x 2 1/2	100	31C250FSC
3/16" KEY		
5/16-24 x 1/2	100	31F50FSC
5/16-24 x 5/8	100	31F62FSC
5/16-24 x 3/4	100	31F75FSC
5/16-24 x 1	100	31F100FSC
5/16-24 x 1 1/4	100	31F125FSC
3/16" KEY		

# SOCKET HEAD CAP SCREWS ALLOY

 <b>FLAT HEAD</b> 		
Size	Pkg Qty	Part#
3/8-16 X 1/2	100	37C50FSC
3/8-16 X 5/8	100	37C62FSC
3/8-16 X 3/4	100	75C75FSC
3/8-16 X 1	100	37C100FSC
3/8-16 X 1 1/4	100	37C125FSC
3/8-16 X 1 1/2	100	37C150FSC
3/8-16 X 1 3/4	50	37C175FSC
3/8-16 X 2	50	37C200FSC
3/8-16 X 2 1/4	50	37C225FSC
3/8-16 X 2 1/2	50	37C250FSC
3/8-16 X 3	50	37C300FSC
7/32" KEY		
3/8-24 X 5/8	100	37F62FSC
3/8-24 X 3/4	100	37F75FSC
3/8-24 X 1	100	37F100FSC
3/8-24 X 1 1/4	100	37F125FSC
3/8-24 X 1 1/2	100	37F150FSC
7/32" KEY		
7/16-14 X 3/4	100	43C75FSC
7/16-14 X 1	100	43C100FSC
7/16-14 X 1 1/4	100	43C125FSC
7/16-14 X 1 1/2	100	43C150FSC
1/4" KEY		
1/2-13 x 3/4	50	50C75FSC
1/2-13 x 1	50	50C100FSC
1/2-13 x 1 1/4	50	50C125FSC
1/2-13 x 1 1/2	50	50C150FSC
1/2-13 X 1 3/4	50	50C175FSC
1/2-13 X 2	50	50C200FSC
1/2-13 X 2 1/4	25	50C225FSC
1/2-13 X 2 1/2	25	50C250FSC
1/2-13 X 3	25	50C300FSC
5/16" KEY		
1/2-20 X 3/4	50	50F75FSC
1/2-20 X 1	50	50F100FSC
1/2-20 X 1 1/4	50	50F125FSC
1/2-20 X 1 1/2	50	50F150FSC
1/2-20 X 1 3/4	50	50F175FSC
1/2-20 X 2	50	50F200FSC
5/16" KEY		

 <b>FLAT HEAD</b> 		
Size	Pkg Qty	Part#
5/8-11 X 1 1/4	25	62C125FSC
5/8-11 X 1 1/2	25	62C150FSC
5/8-11 X 1 3/4	25	62C175FSC
5/8-11 X 2	25	62C200FSC
5/8-11 X 2 1/4	25	62C225FSC
5/8-11 X 2 1/2	25	62C250FSC
5/8-11 X 3	25	62C300FSC
3/8" KEY		
3/4-10 X 1 1/2	25	75C150FSC
3/4-10 X 1 3/4	25	75C175FSC
3/4-10 X 2	25	75C200FSC
3/4-10 X 2 1/2	25	75C250FSC
3/4-10 X 3	25	75C300FSC
1/2" KEY		
 <b>BUTTON HEAD</b> 		
8-32 x 3/8	100	8C37BSC
8-32 x 1/2	100	8C50BSC
8-32 x 5/8	100	8C62BSC
8-32 x 3/4	100	8C75BSC
8-32 x 1	100	8C10BSC
3/32" KEY		
10-24 X 1/4	100	10C25BSC
10-24 x 3/8	100	10C37BSC
10-24 x 1/2	100	10C50BSC
10-24 x 5/8	100	10C62BSC
10-24 x 3/4	100	10C75BSC
10-24 x 1	100	10C100BSC
1/8" KEY		
10-32 X 1/4	100	10F25BSC
10-32 x 3/8	100	10F37BSC
10-32 x 1/2	100	10F50BSC
10-32 x 5/8	100	10F62BSC
10-32 x 3/4	100	10F75BSC
10-32 x 1	100	10F100BSC
1/8" KEY		
1/4-20 X 3/8	100	25C37BSC
1/4-20 X 1/2	100	25C50BSC
1/4-20 X 5/8	100	25C62BSC
1/4-20 X 3/4	100	25C75BSC
1/4-20 X 7/8	100	25C87BSC
1/4-20 X 1	100	25C100BSC
5/32" KEY		

 <b>BUTTON HEAD</b> 		
Size	Pkg Qty	Part#
1/4-28 x 3/8	100	25F37BSC
1/4-28 x 1/2	100	25F50BSC
1/4-28 x 5/8	100	25F62BSC
1/4-28 x 3/4	100	25F75BSC
1/4-28 x 1	100	25F100BSC
5/32" KEY		
5/16-18 X 3/8	100	31C37BSC
5/16-18 x 1/2	100	31C50BSC
5/16-18 x 5/8	100	31C62BSC
5/16-18 x 3/4	100	31C75BSC
5/16-18 x 1	100	31C100BSC
3/16" KEY		
5/16-24 X 3/8	100	31F37BSC
5/16-24 x 1/2	100	31F50BSC
5/16-24 x 5/8	100	31F62BSC
5/16-24 x 3/4	100	31F75BSC
5/16-24 x 1	100	31F100BSC
3/16" KEY		
3/8-16 X 1/2	100	31C50BSC
3/8-16 X 5/8	100	31C62BSC
3/8-16 X 3/4	100	31C75BSC
3/8-16 X 1	50	31C100BSC
3/8-16 X 1 1/4	50	31C125BSC
7/32" KEY		
3/8-24 X 1/2	50	37F50BSC
3/8-24 X 3/4	50	37F75BSC
3/8-24 X 1	50	37F100BSC
7/32" KEY		
1/2-13 x 1	25	50C100BSC
1/2-13 x 1 1/4	25	50C125BSC
1/2-13 x 1 1/2	25	50C150BSC
1/2-13 X 2	25	50C200BSC
5/16" KEY		
5/8-11 x 1	25	62C100BSC
5/8-11 x 1 1/4	25	62C125BSC
5/8-11 x 1 1/2	25	62C150BSC
5/8-11 X 2	25	62C200BSC
3/8" KEY		



# SOCKET SET SCREWS - CUP POINT



Size	Pkg Qty	Part#
4-40 X 1/8	100	4C12SSS
4-40 X 3/16	100	4C18SSS
4-40 X 1/4	100	4C25SSS
4-40 X 5/16	100	4C31SSS
4-40 X 3/8	100	4C37SSS
4-40 X 1/2	100	4C50SSS
4-40 X 5/8	100	4C62SSS
.050" KEY		
4-48 X 1/8	100	4F12SSS
4-48 X 3/16	100	4F18SSS
4-48 X 1/4	100	4F25SSS
.050" KEY		
5-40 X 1/8	100	5C12SSS
5-40 X 3/16	100	5C18SSS
5-40 X 1/4	100	5C25SSS
5-40 X 5/16	100	5C31SSS
5-40 X 3/8	100	5C37SSS
5-40 X 1/2	100	5C50SSS
5-40 X 5/8	100	5C62SSS
5-40 X 3/4	100	5C75SSS
1/16" KEY		
5-48 X 1/8	100	5F12SSS
1/16" KEY		
6-32 X 1/8	100	6C12SSS
6-32 X 3/16	100	6C18SSS
6-32 X 1/4	100	6C25SSS
6-32 X 5/16	100	6C31SSS
6-32 X 3/8	100	6C37SSS
6-32 X 1/2	100	6C50SSS
6-32 X 5/8	100	6C62SSS
6-32 X 3/4	100	6C75SSS
6-32 X 7/8	100	6C87SSS
6-32 X 1	100	6C100SSS
1/16" KEY		
6-40 X 1/8	100	6F12SSS
6-40 X 3/16	100	6F18SSS
6-40 X 1/4	100	6F25SSS
6-40 X 3/8	100	6S37SSS
1/16" KEY		
8-32 X 1/8	100	8C12SSS
8-32 X 3/16	100	8C18SSS
8-32 X 1/4	100	8C25SSS
8-32 X 5/16	100	8C31SSS
8-32 X 3/8	100	8C37SSS
8-32 X 1/2	100	8C50SSS
8-32 X 5/8	100	8C62SSS
8-32 X 3/4	100	8C75SSS
8-32 X 7/8	100	8C87SSS
8-32 X 1	100	8C100SSS
5/64" KEY		

Size	Pkg Qty	Part#
8-36 X 1/8	100	8F12SSS
8-36 X 3/16	100	8F18SSS
8-36 X 1/4	100	8F25SSS
8-36 X 3/8	100	8F37SSS
5/64" KEY		
10-24 X 3/16	100	10C18SSS
10-24 X 1/4	100	10C25SSS
10-24 X 5/16	100	10C31SSS
10-24 X 3/8	100	10C37SSS
10-24 X 1/2	100	10C50SSS
10-24 X 5/8	100	10C62SSS
10-24 X 3/4	100	10C75SSS
10-24 X 7/8	100	10C87SSS
10-24 X 1	100	10C100SSS
10-24 X1 1/4	100	10C125SSS
3/32" KEY		
10-32 X 3/16	100	10F18SSS
10-32 X 1/4	100	10F25SSS
10-32 X 5/16	100	10F31SSS
10-32 X 3/8	100	10F37SSS
10-32 X 1/2	100	10F50SSS
10-32 X 5/8	100	10F62SSS
10-32 X 3/4	100	10F75SSS
10-32 X 1	100	10F100SSS
10-32 X1 1/4	100	10F125SSS
3/32" KEY		
1/4-20 X 3/16	100	25C18SSS
1/4-20 X 1/4	100	25C25SSS
1/4-20 X 5/16	100	25C31SSS
1/4-20 X 3/8	100	25C37SSS
1/4-20 X 1/2	100	25C50SSS
1/4-20 X 5/8	100	25C62SSS
1/4-20 X 3/4	100	25C75SSS
1/4-20 X 7/8	100	25C87SSS
1/4-20 X 1	100	25C100SSS
1/4-20 X 1 1/4	100	25C125SSS
1/4-20 X 1 1/2	100	25C150SSS
1/4-20 X 1 3/4	50	25C175SSS
1/4-20 X 2	50	25C200SSS
1/8" KEY		
1/4-28 X 3/16	100	25F18SSS
1/4-28 X 1/4	100	25F25SSS
1/4-28 X 5/16	100	25F31SSS
1/4-28 X 3/8	100	25F37SSS
1/4-28 X 1/2	100	25F50SSS
1/4-28 X 5/8	100	25F62SSS
1/4-28 X 3/4	100	25F75SSS
1/4-28 X 1	100	25F100SSS
1/4-28 X 1 1/4	100	25F125SSS
1/8" KEY		

Size	Pkg Qty	Part#
5/16-18 X 1/4	100	31C25SSS
5/16-18 X 5/16	100	31C31SSS
5/16-18 X 3/8	100	31C37SSS
5/16-18 X 7/16	100	31C43SSS
5/16-18 X 1/2	100	31C50SSS
5/16-18 X 5/8	100	31C62SSS
5/16-18 X 3/4	100	31C75SSS
5/16-18 X 7/8	100	31C87SSS
5/16-18 X 1	100	31C100SSS
5/16-18 X 1 1/4	100	31C125SSS
5/16-18 X 1 1/2	100	31C150SSS
5/16-18 X 1 3/4	50	31C175SSS
5/16-18 X 2	50	31C200SSS
5/32" KEY		
5/16-24 X 1/4	100	31F25SSS
5/16-24 X 5/16	100	31F31SSS
5/16-24 X 3/8	100	31F37SSS
5/16-24 x 1/2	100	31F50SSS
5/16-24 x 5/8	100	31F62SSS
5/16-24 x 3/4	100	31F75SSS
5/16-24 x 1	100	31F100SSS
5/32" KEY		
3/8-16 X 1/4	100	37C25SSS
3/8-16 X 5/16	100	37C31SSS
3/8-16 X 3/8	100	37C37SSS
3/8-16 X 7/16	100	37C43SSS
3/8-16 X 1/2	100	37C50SSS
3/8-16 X 5/8	100	37C62SSS
3/8-16 X 3/4	100	37C75SSS
3/8-16 X 7/8	100	37C87SSS
3/8-16 X 1	100	37C100SSS
3/8-16 X 1 1/4	100	37C125SSS
3/8-16 X 1 1/2	100	37C150SSS
3/8-16 X 1 3/4	50	37C175SSS
3/8-16 X 2	50	37C200SSS
3/8-16 X 2 1/2	50	37C250SSS
7/32" KEY		
3/8-24 X 1/4	100	37F25SSS
3/8-24 X 3/8	100	37F37SSS
3/8-24 X 1/2	100	37F50SSS
3/8-24 X 5/8	100	37F62SSS
3/8-24 X 3/4	100	37F75SSS
3/8-24 X 1	100	37F100SSS
3/8-24 X 1 1/4	100	37F125SSS
3/8-24 X 1 1/2	100	37F150SSS
3/8" KEY		



## SOCKET SET SCREWS CUP POINT



Size	Pkg Qty	Part#
7/16-14 X 3/8	100	43C37SSS
7/16-14 X 7/16	100	43C43SSS
7/16-14 X 1/2	100	43C50SSS
7/16-14 X 5/8	100	43C62SSS
7/16-14 X 3/4	100	43C75SSS
7/16-14 X 7/8	50	43C87SSS
7/16-14 X 1	50	43C100SSS
7/16-14 X 1 1/4	50	43C125SSS
7/16-14 X 1 1/2	50	43C150SSS
7/16-14 X 2	50	43C200SSS
7/32" KEY		
7/16-20 X 3/8	100	43F37SSS
7/16-20 X 7/16	100	43F43SSS
7/16-20 X 1/2	100	43F50SSS
7/32" KEY		
1/2-13 X 3/8	100	50C37SSS
1/2-13 X 1/2	100	50C50SSS
1/2-13 X 5/8	100	50C62SSS
1/2-13 X 3/4	100	50C75SSS
1/2-13 X 7/8	50	50C87SSS
1/2-13 X 1	50	50C100SSS
1/2-13 X 1 1/4	50	50C125SSS
1/2-13 X 1 1/2	50	50C150SSS
1/2-13 X 1 3/4	25	50C175SSS
1/2-13 X 2	25	50C200SSS
1/2-13 X 2 1/2	25	50C250SSS
1/2-13 X 3	25	50C300SSS
1/4" KEY		

Size	Pkg Qty	Part#
1/2-20 X 1/2	100	50F50SSS
1/2-20 X 3/4	100	50F75SSS
1/2-10 X 1	50	50F100SSS
5/64" KEY		
5/8-11 X 1/2	100	62C50SSS
5/8-11 X 5/8	50	62C62SSS
5/8-11 X 3/4	50	62C75SSS
5/8-11 X 1	50	62C100SSS
5/8-11 X 1 1/4	25	62C125SSS
5/8-11 X 1 1/2	25	62C150SSS
5/8-11 X 1 3/4	25	62C175SSS
5/8-11 X 2	25	62C200SSS
5/8-11 X 2 1/2	10	62C250SSS
5/8-11 X 3	10	62C300SSS
5/16" KEY		
5/8-18 X 5/8	50	62F62SSS
5/8-18 X 1	50	62F100SSS
5/16" KEY		

Size	Pkg Qty	Part#
3/4-10 X 5/8	50	75C62SSS
3/4-10 X 3/4	50	75C75SSS
3/4-10 X 1	50	75C100SSS
3/4-10 X 1 1/4	25	75C125SSS
3/4-10 X 1 1/2	25	75C150SSS
3/4-10 X 1 3/4	10	75C175SSS
3/4-10 X 2	10	75C200SSS
3/4-10 X 2 1/2	10	75C250SSS
3/4-10 X 3	10	75C300SSS
3/8" KEY		
7/8 X 7/8	10	87C87SSS
7/8 X 1	10	87C100SSS
7/8 X 2 1/2	10	87C250SSS
1/2" KEY		
1-8 X 1	10	100C100SSS
1-8 X 1 1/2	10	100C150SSS
1-8 X 2	10	100C200SSS
1-8 X 3	10	100C300SSS
9/16" KEY		

### MANY OTHER STYLES AVAILABLE INCLUDING



CONE

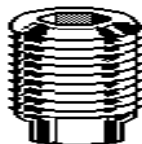

FULL DOG

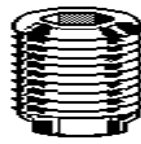

HALF DOG

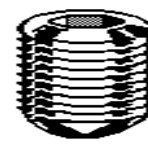

OVAL

UNLIMITED SUPPLIES



## SOCKET SHOULDER BOLTS

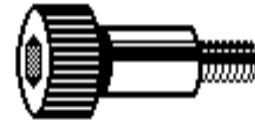

SIZE	QTY	PART NO.	SIZE	QTY	PART NO.
1/4 (10-24) X 1/2	25	25X50SSB	1/2 (3/8-16) X 3 1/2	25	50X350SSB
1/4 (10-24) X 3/4	25	25X75SSB	1/2 (3/8-16) X 3 3/4	25	50X375SSB
1/4 (10-24) X 1	25	25X100SSB	1/2 (3/8-16) X 4	25	50X400SSB
1/4 (10-24) X 1 1/4	25	25X125SSB	1/2 (3/8-16) X 4 1/4	25	50X425SSB
1/4 (10-24) X 1 1/2	25	25X150SSB	1/2 (3/8-16) X 4 1/2	10	50X450SSB
			1/2 (3/8-16) X 4 3/4	10	50X475SSB
5/16 (1/4-20) X 3/8	25	31X37SSB	1/2 (3/8-16) X 5	10	50X500SSB
5/16 (1/4-20) X 1/2	25	31X50SSB	1/2 (3/8-16) X 5 1/2	10	50X550SSB
5/16 (1/4-20) X 5/8	25	31X62SSB	1/2 (3/8-16) X 6	10	50X600SSB
5/16 (1/4-20) X 3/4	25	31X75SSB			
5/16 (1/4-20) X 1 1/2	25	31X150SSB	5/8 (1/2-13) X 1	25	62X100SSB
5/16 (1/4-20) X 1 3/4	25	31X175SSB	5/8 (1/2-13) X 1 1/4	25	62X125SSB
5/16 (1/4-20) X 2	25	31X200SSB	5/8 (1/2-13) X 1 1/2	25	62X150SSB
			5/8 (1/2-13) X 1 3/4	25	62X175SSB
3/8 (5/16-18) X 3/8	25	37X37SSB	5/8 (1/2-13) X 2	25	62X200SSB
3/8 (5/16-18) X 1/2	25	37X50SSB	5/8 (1/2-13) X 2 1/4	25	62X225SSB
3/8 (5/16-18) X 5/8	25	37X62SSB	5/8 (1/2-13) X 2 1/2	25	62X250SSB
3/8 (5/16-18) X 3/4	25	37X75SSB	5/8 (1/2-13) X 3	25	62X300SSB
3/8 (5/16-18) X 1	25	37X100SSB	5/8 (1/2-13) X 3 1/4	25	62X325SSB
3/8 (5/16-18) X 1 1/4	25	37X125SSB	5/8 (1/2-13) X 3 1/2	25	62X350SSB
3/8 (5/16-18) X 1 1/2	25	37X150SSB	5/8 (1/2-13) X 4	10	62X400SSB
3/8 (5/16-18) X 1 3/4	25	37X175SSB	5/8 (1/2-13) X 4 1/4	10	62X425SSB
3/8 (5/16-18) X 2	25	37X200SSB	5/8 (1/2-13) X 4 1/2	10	62X450SSB
3/8 (5/16-18) X 2 1/4	25	37X225SSB	5/8 (1/2-13) X 4 3/4	10	62X475SSB
3/8 (5/16-18) X 2 1/2	25	37X250SSB	5/8 (1/2-13) X 5	10	62X500SSB
3/8 (5/16-18) X 2 3/4	25	37X275SSB	5/8 (1/2-13) X 5 1/4	10	62X525SSB
3/8 (5/16-18) X 3	25	37X300SSB	5/8 (1/2-13) X 5 1/2	10	62X550SSB
3/8 (5/16-18) X 3 1/4	25	37X325SSB	5/8 (1/2-13) X 6	10	62X600SSB
3/8 (5/16-18) X 3 1/2	25	37X350SSB	5/8 (1/2-13) X 6 1/2	10	62X650SSB
3/8 (5/16-18) X 3 3/4	25	37X375SSB	5/8 (1/2-13) X 7	10	62X700SSB
3/8 (5/16-18) X 4	25	37X400SSB			
1/2 (3/8-16) X 5/8	25	50X62SSB	3/4 (5/8-11) X 3/4	25	75X75SSB
1/2 (3/8-16) X 3/4	25	50X75SSB	3/4 (5/8-11) X 1	25	75X100SSB
1/2 (3/8-16) X 1	25	50X100SSB	3/4 (5/8-11) X 1 1/4	25	75X125SSB
1/2 (3/8-16) X 1 1/4	25	50X125SSB	3/4 (5/8-11) X 1 1/2	10	75X150SSB
1/2 (3/8-16) X 1 1/2	25	50X150SSB	3/4 (5/8-11) X 1 3/4	10	75X175SSB
1/2 (3/8-16) X 1 3/4	25	50X175SSB	3/4 (5/8-11) X 2	10	75X200SSB
1/2 (3/8-16) X 2	25	50X200SSB	3/4 (5/8-11) X 2 1/4	10	75X225SSB
1/2 (3/8-16) X 2 1/4	25	50X225SSB	3/4 (5/8-11) X 2 1/2	10	75X250SSB
1/2 (3/8-16) X 2 1/2	25	50X250SSB	3/4 (5/8-11) X 2 3/4	10	75X275SSB
1/2 (3/8-16) X 2 3/4	25	50X275SSB	3/4 (5/8-11) X 3	10	75X300SSB
1/2 (3/8-16) X 3	25	50X300SSB	3/4 (5/8-11) X 3 1/4	10	75X325SSB
1/2 (3/8-16) X 3 1/4	25	50X325SSB	3/4 (5/8-11) X 3 1/2	10	75X350SSB



## SOCKET SHOULDER BOLTS

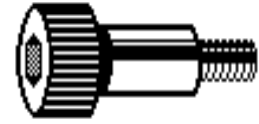

### 3/4 (5/8-11) SOCKET SHOULDER BOLTS CONTINUED

SIZE	QTY	PART NO.
3/4 (5/8-11) X 3 3/4	10	75X375SSB
3/4 (5/8-11) X 4	10	75X400SSB
3/4 (5/8-11) X 4 1/4	10	75X425SSB
3/4 (5/8-11) X 4 1/2	10	75X450SSB
		75X475SSB
3/4 (5/8-11) X 4 3/4	10	75X500SSB
3/4 (5/8-11) X 5	10	75X550SSB
3/4 (5/8-11) X 5 1/2	10	75X600SSB
3/4 (5/8-11) X 6	10	
		75X650SSB
3/4 (5/8-11) X 6 1/2	10	75X700SSB
3/4 (5/8-11) X 7	10	

**WE ARE UNLIMITED SUPPLIES!!**  
**IF YOU NEED AN ITEM NOT LISTED**  
**PLEASE CALL**  
**WE WILL BE HAPPY TO HELP**  
**763-746-5150**  
**[www.unlimited-usa.com](http://www.unlimited-usa.com)**

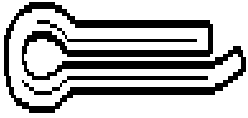

# COTTER PINS



SIZE	QTY	PART NO.
1/16 X 1/2	100	116X50CP
1/16 X 3/4	100	116X75CP
1/16 X 1	100	116X100CP
1/16 X 1 1/4	100	116X125CP
1/16 X 1 1/2	100	116X150CP
1/16 X 1 3/4	100	116X175CP
1/16 X 2	100	116X200CP
3/32 X 1/2	100	332X50CP
3/32 X 3/4	100	332X75CP
3/32 X 1	100	332X100CP
3/32 X 1 1/4	100	332X125CP
3/32 X 1 1/2	100	332X150CP
3/32 X 2	100	332X200CP
3/32 X 2 1/2	100	332X250CP
1/8 X 3/4	100	18X75CP
1/8 X 1	100	18X100CP
1/8 X 1 1/4	100	18X125CP
1/8 X 1 1/2	100	18X150CP
1/8 X 1 3/4	100	18X175CP
1/8 X 2	100	18X200CP
1/8 X 2 1/2	100	18X250CP
1/8 X 3	100	18X300CP
5/32 X 3/4	100	532X75CP
5/32 X 1	100	532X100CP
5/32 X 1 1/4	100	532X125CP
5/32 X 1 1/2	100	532X150CP
5/32 X 1 3/4	100	532X175CP
5/32 X 2	100	532X200CP
5/32 X 2 1/4	100	532X225CP
5/32 X 2 1/2	100	532X250CP
5/32 X 3	100	532X300CP

SIZE	QTY	PART NO.
3/16 X 1	100	316X100CP
3/16 X 1 1/4	100	316X125CP
3/16 X 1 1/2	100	316X150CP
3/16 X 2 1/4	100	316X225CP
3/16 X 2 1/2	100	316X250CP
3/16 X 3	100	316X300CP
3/16 X 3 1/2	100	316X350CP
3/16 X 4	100	316X400CP
1/4 X 1	100	14X100CP
1/4 X 1 1/4	100	14X125CP
1/4 X 1 1/2	100	14X150CP
1/4 X 1 3/4	100	14X175CP
1/4 X 2	100	14X200CP
1/4 X 2 1/4	100	14X225CP
1/4 X 2 1/2	100	14X250CP
1/4 X 3	100	14X300CP
1/4 X 3 1/2	100	14X350CP
1/4 X 4	100	14X400CP
5/16 X 1	100	516X100CP
5/16 X 1 1/2	100	516X150CP
5/16 X 1 3/4	100	516X175CP
5/16 X 2	100	516X200CP
5/16 X 2 1/2	100	516X250CP
5/16 X 3	100	516X300CP
5/16 X 3 1/2	100	516X350CP
5/16 X 4	100	516X400CP
3/8 X 1 1/2	100	38X150CP
3/8 X 2	100	38X200CP
3/8 X 2 1/2	100	38X250CP
3/8 X 3	100	38X300CP
3/8 X 4	100	38X400CP

**UNLIMITED OTHER SIZES AND STAINLESS STEEL OR  
BRASS AVAILABLE UPON REQUEST**

**CALL 763-746-5150  
www.unlimited-usa.com**





# CLEVIS PINS



SIZE	QTY	PART NO.
3/16 X 1/2	25	316X50CL
3/16 X 5/8	25	316X62CL
3/16 X 3/4	25	316X75CL
3/16 X 7/8	25	316X87CL
3/16 X 1	25	316X100CL
3/16 X 1 1/4	25	316X125CL
3/16 X 1 1/2	25	316X150CL
3/16 X 1 3/4	25	316X175CL
3/16 X 2	25	316X200CL
3/16 X 2 1/2	25	316X250CL
3/16 X 3	25	316X300CL
1/4 X 1/2	25	14X50CL
1/4 X 5/8	25	14X62CL
1/4 X 3/4	25	14X75CL
1/4 X 7/8	25	14X87CL
1/4 X 1	25	14X100CL
1/4 X 1 1/4	25	14X125CL
1/4 X 1 1/2	25	14X150CL
1/4 X 1 3/4	25	14X175CL
1/4 X 2	25	14X200CL
1/4 X 2 1/4	25	14X225CL
1/4 X 2 1/2	25	14X250CL
1/4 X 2 3/4	25	14X275CL
1/4 X 3	25	14X300CL
1/4 X 3 1/2	25	14X350CL
1/4 X 4	25	14X400CL
1/4 X 5	25	14X500CL
5/16 X 1/2	10	516X50CL
5/16 X 3/4	10	516X75CL
5/16 X 1	10	516X100CL
5/16 X 1 1/4	10	516X125CL
5/16 X 1 1/2	10	516X150CL
5/16 X 1 3/4	10	516X175CL
5/16 X 2	10	516X200CL
5/16 X 2 1/4	10	516X225CL
5/16 X 2 1/2	10	516X250CL
5/16 X 2 3/4	10	516X275CL
5/16 X 3	10	516X300CL
5/16 X 3 1/2	10	516X350CL
5/16 X 4	10	516X400CL
5/16 X 5	10	516X500CL
5/16 X 6	10	516X600CL

SIZE	QTY	PART NO.
3/8 X 3/4	10	38X75CL
3/8 X 1	10	38X100CL
3/8 X 1 1/4	10	38X125CL
3/8 X 1 1/2	10	38X150CL
3/8 X 1 3/4	10	38X175CL
3/8 X 2	10	38X200CL
3/8 X 2 1/4	10	38X225CL
3/8 X 2 1/2	10	38X250CL
3/8 X 2 3/4	10	38X275CL
3/8 X 3	10	38X300CL
3/8 X 3 1/4	10	38X325CL
3/8 X 3 1/2	10	38X350CL
3/8 X 3 3/4	10	38X375CL
3/8 X 4	10	38X400CL
3/8 X 5	10	38X500CL
3/8 X 6	10	38X600CL
7/16 X 1	10	716X100CL
7/16 X 1 1/4	10	716X125CL
7/16 X 1 1/2	10	716X150CL
7/16 X 1 3/4	10	716X175CL
7/16 X 2	10	716X200CL
7/16 X 2 1/4	10	716X225CL
7/16 X 2 1/2	10	716X250CL
7/16 X 2 3/4	10	716X275CL
7/16 X 3	10	716X300CL
7/16 X 3 1/2	10	716X350CL
7/16 X 4	10	716X400CL
7/16 X 5	10	716X500CL
7/16 X 6	10	716X600CL
1/2 X 1	10	12X100CL
1/2 X 1 1/4	10	12X125CL
1/2 X 1 1/2	10	12X150CL
1/2 X 1 3/4	10	12X175CL
1/2 X 2	10	12X200CL
1/2 X 2 1/4	10	12X225CL
1/2 X 2 1/2	10	12X250CL
1/2 X 2 3/4	10	12X275CL
1/2 X 3	10	12X300CL
1/2 X 3 1/2	10	12X350CL
1/2 X 4	10	12X400CL
1/2 X 5	10	12X500CL
1/2 X 6	10	12X600CL



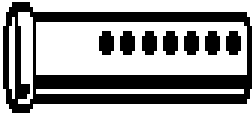

# UNIVERSAL CLEVIS PINS

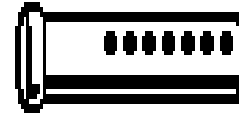

SIZE	QTY	PART NO.
3/16 X 1	25	316X100UCL
3/16 X 1 1/4	25	316X125UCL
3/16 X 1 1/2	25	316X150UCL
3/16 X 1 3/4	25	316X175UCL
3/16 X 2	25	316X200UCL
3/16 X 2 1/2	25	316X250UCL
3/16 X 3	25	316X300UCL
1/4 X 1	25	14X100UCL
1/4 X 1 1/4	25	14X125UCL
1/4 X 1 1/2	25	14X150UCL
1/4 X 1 3/4	25	14X175UCL
1/4 X 2	25	14X200UCL
1/4 X 2 1/4	25	14X225UCL
1/4 X 2 1/2	25	14X250UCL
1/4 X 2 3/4	25	14X275UCL
1/4 X 3	25	14X300UCL
1/4 X 3 1/2	25	14X350UCL
1/4 X 4	25	14X400UCL
1/4 X 5	25	14X500UCL
5/16 X 1	10	516X100UCL
5/16 X 1 1/4	10	516X125UCL
5/16 X 1 1/2	10	516X150UCL
5/16 X 1 3/4	10	516X175UCL
5/16 X 2	10	516X200UCL
5/16 X 2 1/2	10	516X225UCL
5/16 X 2 3/4	10	516X250UCL
5/16 X 3	10	516X300UCL
5/16 X 3 1/2	10	516X350UCL
5/16 X 4	10	516X400UCL
5/16 X 5	10	516X500UCL
5/16 X 6	10	516X600UCL

SIZE	QTY	PART NO.
3/8 X 1	10	38X100UCL
3/8 X 1 1/4	10	38X125UCL
3/8 X 1 1/2	10	38X150UCL
3/8 X 1 3/4	10	38X175UCL
3/8 X 2	10	38X200UCL
3/8 X 2 1/4	10	38X225UCL
3/8 X 2 1/2	10	38X250UCL
3/8 X 2 3/4	10	38X275UCL
3/8 X 3	10	38X300UCL
3/8 X 3 1/4	10	38X325UCL
3/8 X 3 1/2	10	38X350UCL
3/8 X 3 3/4	10	38X375UCL
3/8 X 4	10	38X400UCL
3/8 X 5	10	38X500UCL
3/8 X 6	10	38X600UCL
7/16 X 1	10	716X100UCL
7/16 X 1 1/4	10	716X125UCL
7/16 X 1 1/2	10	716X150UCL
7/16 X 1 3/4	10	716X175UCL
7/16 X 2	10	716X200UCL
7/16 X 2 1/4	10	716X225UCL
7/16 X 2 1/2	10	716X250UCL
7/16 X 2 3/4	10	716X275UCL
7/16 X 3	10	716X300UCL
7/16 X 3 1/2	10	716X350UCL
7/16 X 4	10	716X400UCL
7/16 X 5	10	716X500UCL
7/16 X 6	10	716X600UCL
1/2 X 1	10	12X100UCL
1/2 X 1 1/4	10	12X125UCL
1/2 X 1 1/2	10	12X150UCL
1/2 X 1 3/4	10	12X175UCL
1/2 X 2	10	12X200UCL
1/2 X 2 1/4	10	12X225UCL
1/2 X 2 1/2	10	12X250UCL
1/2 X 2 3/4	10	12X275UCL
1/2 X 3	10	12X300UCL
1/2 X 3 1/2	10	12X350UCL
1/2 X 4	10	12X400UCL
1/2 X 5	10	12X500UCL
1/2 X 6	10	12X600UCL

# BRIDGE PINS, HITCHPINS & SNAPPER PINS

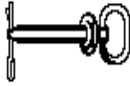

 <b>BRIDGE PINS (HAIRPIN COTTERS)</b>		
SHAFT SIZE	QTY	PART NO.
<b>1/8 X 3/16</b>	<b>100</b>	<b>100-20</b>
<b>3/16</b>	<b>100</b>	<b>101-20</b>
<b>1/4 X 5/16</b>	<b>100</b>	<b>103-20</b>
<b>5/16 X 3/8</b>	<b>50</b>	<b>105-20</b>
<b>7/16 X 1/2</b>	<b>50</b>	<b>107-20</b>
<b>5/8 X 3/4</b>	<b>25</b>	<b>109-20</b>
<b>7/8 X 1</b>	<b>25</b>	<b>111-20</b>

 <b>HITCHPINS</b>		
SHANK SIZE	QTY	PART NO.
<b>3/8 X 4</b>	<b>10</b>	<b>38X400HP</b>
<b>1/2 X 4</b>	<b>10</b>	<b>12X400HP</b>
<b>5/8 X 4</b>	<b>10</b>	<b>58X400HP</b>
<b>5/8 X 5</b>	<b>10</b>	<b>58X500HP</b>
<b>5/8 X 6</b>	<b>10</b>	<b>58X600HP</b>
<b>3/4 X 4 1/4</b>	<b>10</b>	<b>34X425HP</b>
<b>3/4 X 5 1/4</b>	<b>10</b>	<b>34X525HP</b>
<b>3/4 X 6 1/4</b>	<b>10</b>	<b>34X625HP</b>
<b>7/8 X 4 1/4</b>	<b>10</b>	<b>78X425HP</b>
<b>7/8 X 6 1/2</b>	<b>10</b>	<b>78X650HP</b>
<b>1 X 4 3/4</b>	<b>10</b>	<b>100X475HP</b>
<b>1 X 6 3/4</b>	<b>10</b>	<b>100X675HP</b>
<b>1 1/8 X 7</b>	<b>10</b>	<b>118X700HP</b>
<b>1 1/4 X 7</b>	<b>10</b>	<b>125X700HP</b>

 <b>LYNCH PINS</b>		
SIZE	QTY	PART NO.
<b>3/16 x 1 1/4</b>	<b>10</b>	<b>316MLP</b>
<b>3/16 x 1 9/16</b>	<b>10</b>	<b>316LP</b>
<b>1/4 x 1 9/16</b>	<b>10</b>	<b>14LP</b>
<b>5/16 x 1 9/16</b>	<b>10</b>	<b>516LP</b>
<b>7/16 x 1 9/16</b>	<b>10</b>	<b>716LP</b>
<b>7/16 x 1 31/32</b>	<b>10</b>	<b>716LPL</b>
<b>7/16 x 1 9/16</b>	<b>10</b>	<b>716LPHD</b>
WITH CHAIN & COTTER PIN		
<b>3/16 x 1 9/16</b>	<b>10</b>	<b>316LPC</b>
<b>1/4 x 1 9/16</b>	<b>10</b>	<b>14LPC</b>
<b>5/16 x 1 9/16</b>	<b>10</b>	<b>516LPC</b>
<b>7/16 x 1 9/16</b>	<b>10</b>	<b>716LPC</b>
<b>7/16 x 1 31/32</b>	<b>10</b>	<b>716LPLC</b>

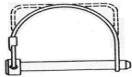
 <b>SNAPPER PINS</b>		
SIZE	QTY	PART NO.
<b>1/4 X 1 3/4</b>	<b>10</b>	<b>14X175SP</b>
<b>5/16 X 2 1/2</b>	<b>10</b>	<b>516X250SP</b>
<b>3/8 X 1 1/2</b>	<b>10</b>	<b>38X150SP</b>
<b>3/8 X 2 1/4</b>	<b>10</b>	<b>38X225SP</b>
<b>3/8 X 2 1/2</b>	<b>10</b>	<b>38X250SP</b>
<b>1/4 X 2 1/2</b>	<b>10</b>	<b>14X250SP</b>
<b>5/16 X 1 3/4</b>	<b>10</b>	<b>516X175SP</b>
<b>5/16 X 3 1/2</b>	<b>10</b>	<b>516X350SP</b>
<b>3/8 X 3</b>	<b>10</b>	<b>38X300SP</b>



# COTTERLESS HITCH PINS



SIZE	QTY	PART NO.
3/16 X 1	10	316X100CHP
3/16 X 1 1/2	10	316X150CHP
3/16 X 2	10	316X200CHP
3/16 X 2 1/2	10	316X250CHP
3/16 X 3	10	316X300CHP
1/4 X 1	10	14X100CHP
1/4 X 1 1/2	10	14X150CHP
1/4 X 2	10	14X200CHP
1/4 X 2 1/2	10	14X250CHP
1/4 X 3	10	14X300CHP
1/4 X 3 1/2	10	14X350CHP
1/4 X 4	10	14X400CHP
1/4 X 4 1/2	10	14X450CHP
1/4 X 5	10	14X500CHP
5/16 X 1	10	516X100CHP
5/16 X 1 1/2	10	516X150CHP
5/16 X 2	10	516X200CHP
5/16 X 2 1/2	10	516X250CHP
5/16 X 3	10	516X300CHP
5/16 X 3 1/2	10	516X350CHP
5/16 X 4	10	516X400CHP
5/16 X 4 1/2	10	516X450CHP
5/16 X 5	10	516X500CHP
5/16 X 5 1/2	10	516X550CHP
3/8 X 1	10	38X100CHP
3/8 X 1 1/2	10	38X150CHP
3/8 X 2	10	38X200CHP

SIZE	QTY	PART NO.
3/8 X 2 1/2	10	38X250CHP
3/8 X 3	10	38X300CHP
3/8 X 3 1/2	10	38X350CHP
3/8 X 4	10	38X400CHP
3/8 X 4 1/2	10	38X450CHP
3/8 X 5	10	38X500CHP
3/8 X 5 1/2	10	38X550CHP
7/16 X 1	10	716X100CHP
7/16 X 1 1/2	10	716X150CHP
7/16 X 2	10	716X200CHP
7/16 X 2 1/2	10	716X250CHP
7/16 X 3	10	716X300CHP
7/16 X 3 1/2	10	716X350CHP
7/16 X 4	10	716X400CHP
7/16 X 4 1/2	10	716X450CHP
7/16 X 5	10	716X500CHP
7/16 X 5 1/2	10	716X550CHP
1/2 X 1	10	12X100CHP
1/2 X 1 1/2	10	12X150CHP
1/2 X 2	10	12X200CHP
1/2 X 2 1/2	10	12X250CHP
1/2 X 3	10	12X300CHP
1/2 X 3 1/2	10	12X350CHP
1/2 X 4	10	12X400CHP
1/2 X 4 1/2	10	12X450CHP
1/2 X 5	10	12X500CHP
1/2 X 5 1/2	10	12X550CHP

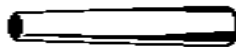

# TAPER PINS



SIZE	QTY	PART NO.	SIZE	QTY	PART NO.
3/0 X 1 1/2	10	000X150TP	3 X 1 1/4	10	3X125TP
2/0 X 1 1/2	10	00X150TP	3 X 2 1/2	10	3X250TP
2/0 X 2	10	00X200TP	3 X 3 1/2	10	3X350TP
1/0 X 1 1/2	10	0X150TP	4 X 1 1/4	10	4X125TP
1/0 X 2	10	0X200TP	4 X 2	10	4X200TP
1/0 X 3	10	0X300TP	4 X 3	10	4X300TP
1 X 1 1/2	10	1X150TP	5 X 1 1/2	10	5X150TP
1 X 2	10	1X200TP	5 X 2 1/2	10	5X250TP
1 X 3	10	1X300TP	5 X 3 1/2	10	5X350TP
2 X 1 1/4	10	2X125TP	6 X 1 1/2	10	6X150TP
2 X 2	10	2X200TP	6 X 2 1/2	10	6X250TP
2 X 3	10	2X300TP	6 X 3 1/2	10	6X350TP

UNLIMITED SUPPLIES

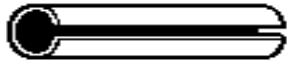

# SPRING ROLL PINS

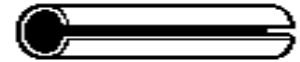

SIZE	QTY	PART NO.
1/16 X 1/4	100	116X25RP
1/16 X 3/8	100	116X37RP
1/16 X 1/2	100	116X50RP
1/16 X 5/8	100	116X62RP
1/16 X 3/4	100	116X75RP
1/16 X 7/8	100	116X87RP
1/16 X 1	100	116X100RP
5/64 X 1/4	100	564X25RP
5/64 X 3/8	100	564X37RP
5/64 X 1/2	100	564X50RP
5/64 X 5/8	100	564X62RP
5/64 X 3/4	100	564X75RP
5/64 X 7/8	100	564X87RP
5/64 X 1	100	564X100RP
5/64 X 1 1/8	100	564X112RP
5/64 X 1 1/4	100	564X125RP
5/64 X 1 1/2	100	564X150RP
3/32 X 1/4	100	332X25RP
3/32 X 3/8	100	332X37RP
3/32 X 1/2	100	332X50RP
3/32 X 5/8	100	332X62RP
3/32 X 3/4	100	332X75RP
3/32 X 7/8	100	332X87RP
3/32 X 1	100	332X100RP
3/32 X 1 1/8	100	332X112RP
3/32 X 1 1/4	100	332X125RP
3/32 X 1 3/8	100	332X137RP
3/32 X 1 1/2	100	332X150RP
1/8 X 1/4	100	18X25RP
1/8 X 3/8	100	18X37RP
1/8 X 1/2	100	18X50RP
1/8 X 5/8	100	18X62RP
1/8 X 3/4	100	18X75RP
1/8 X 7/8	100	18X87RP
1/8 X 1	100	18X100RP
1/8 X 1 1/8	100	18X112RP
1/8 X 1 1/4	100	18X125RP
1/8 X 1 3/8	100	18X137RP
1/8 X 1 1/2	100	18X150RP
1/8 X 1 5/8	100	18X162RP
1/8 X 1 3/4	100	18X175RP
1/8 X 1 7/8	100	18X187RP
1/8 X 2	100	18X200RP

SIZE	QTY	PART NO.
5/32 X 1/4	100	532X25RP
5/32 X 3/8	100	532X37RP
5/32 X 1/2	100	532X50RP
5/32 X 5/8	100	532X62RP
5/32 X 3/4	100	532X75RP
5/32 X 7/8	100	532X87RP
5/32 X 1	100	532X100RP
5/32 X 1 1/8	100	532X112RP
5/32 X 1 1/4	100	532X125RP
5/32 X 1 3/8	100	532X137RP
5/32 X 1 1/2	100	532X150RP
5/32 X 1 5/8	100	532X162RP
5/32 X 1 3/4	100	532X175RP
5/32 X 1 7/8	100	532X187RP
5/32 X 2	100	532X200RP
5/32 X 2 1/4	100	532X225RP
5/32 X 2 1/2	100	532X250RP
3/16 X 3/8	100	316X37RP
3/16 X 1/2	100	316X50RP
3/16 X 5/8	100	316X62RP
3/16 X 3/4	100	316X75RP
3/16 X 7/8	100	316X87RP
3/16 X 1	100	316X100RP
3/16 X 1 1/8	100	316X112RP
3/16 X 1 1/4	100	316X125RP
3/16 X 1 3/8	100	316X137RP
3/16 X 1 1/2	100	316X150RP
3/16 X 1 5/8	100	316X162RP
3/16 X 1 3/4	100	316X175RP
3/16 X 1 7/8	100	316X187RP
3/16 X 2	100	316X200RP
3/16 X 2 1/4	100	316X225RP
3/16 X 2 1/2	100	316X250RP

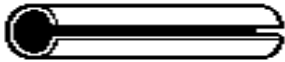

# SPRING ROLL PINS

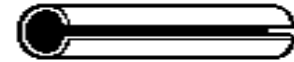

SIZE	QTY	PART NO.
7/32 X 5/8	100	732X62RP
7/32 X 3/4	100	732X75RP
7/32 X 7/8	100	732X87RP
7/32 X 1	100	732X100RP
7/32 X 1 1/8	100	732X112RP
7/32 X 1 1/4	100	732X125RP
7/32 X 1 3/8	100	732X137RP
7/32 X 1 1/2	100	732X150RP
7/32 X 1 5/8	100	732X162RP
7/32 X 1 3/4	100	732X175RP
7/32 X 1 7/8	100	732X187RP
7/32 X 2	100	732X200RP
7/32 X 2 1/4	100	732X225RP
7/32 X 2 1/2	100	732X250RP
7/32 X 2 3/4	100	732X275RP
7/32 X 3	100	732X300RP
1/4 X 1/2	50	14X50RP
1/4 X 5/8	50	14X62RP
1/4 X 3/4	50	14X75RP
1/4 X 7/8	50	14X87RP
1/4 X 1	50	14X100RP
1/4 X 1 1/8	50	14X112RP
1/4 X 1 1/4	50	14X125RP
1/4 X 1 3/8	50	14X137RP
1/4 X 1 1/2	50	14X150RP
1/4 X 1 5/8	50	14X162RP
1/4 X 1 3/4	50	14X175RP
1/4 X 1 7/8	50	14X187RP
1/4 X 2	50	14X200RP
1/4 X 2 1/4	50	14X225RP
1/4 X 2 1/2	50	14X250RP
1/4 X 2 3/4	50	14X275RP
1/4 X 3	50	14X300RP
1/4 X 3 1/4	50	14X325RP
1/4 X 3 1/2	50	14X350RP
5/16 X 3/4	50	516X75RP
5/16 X 7/8	50	516X87RP
5/16 X 1	50	516X100RP
5/16 X 1 1/4	50	516X125RP
5/16 X 1 1/2	50	516X150RP

SIZE	QTY	PART NO.
5/16 X 1 3/4	50	516X25RP
5/16 X 1 7/8	50	516X37RP
5/16 X 2	50	516X50RP
5/16 X 2 1/4	50	516X62RP
5/16 X 2 1/2	50	516X75RP
5/16 X 2 3/4	50	516X87RP
5/16 X 3	50	516X100RP
5/16 X 3 1/4	50	516X112RP
5/16 X 3 1/2	50	516X125RP
5/16 X 3 3/4	50	516X137RP
5/16 X 4	50	516X150RP
3/8 X 3/4	50	38X75RP
3/8 X 1	50	38X100RP
3/8 X 1 1/4	50	38X125RP
3/8 X 1 1/2	50	38X150RP
3/8 X 1 3/4	50	38X175RP
3/8 X 2	50	38X200RP
3/8 X 2 1/4	50	38X225RP
3/8 X 2 1/2	50	38X250RP
3/8 X 2 3/4	50	38X275RP
3/8 X 3	50	38X300RP
3/8 X 3 1/2	50	38X350RP
3/8 X 4	50	38X400RP
7/16 X 1	50	716X100RP
7/16 X 1 1/4	50	716X125RP
7/16 X 1 1/2	50	716X150RP
7/16 X 1 3/4	50	716X175RP
7/16 X 2	50	716X200RP
7/16 X 2 1/4	50	716X225RP
7/16 X 2 1/2	50	716X250RP
7/16 X 2 3/4	50	716X275RP
7/16 X 3	50	716X300RP
7/16 X 3 1/2	50	716X350RP
7/16 X 4	50	716X400RP
1/2 X 1 1/4	50	12X125RP
1/2 X 1 1/2	50	12X150RP
1/2 X 1 3/4	50	12X175RP
1/2 X 2	50	12X200RP
1/2 X 2 1/4	50	12X225RP
1/2 X 2 1/2	50	12X250RP
1/2 X 2 3/4	50	12X275RP
1/2 X 3	50	12X300RP

# KEYSTOCK & WOODRUFF KEYS



SIZE	QTY	PART NO.	SIZE	KEY NUMBER	PART NO.
1/8 X 1/8 X 12"	3	1/8 X 1/8 X 12"	1/16 X 1/4	201	116X25WK
3/16 X 1/8 X 12"	3	3/16 X 1/8 X 12"	1/16 X 5/16	206	116X31WK
3/16 X 3/16 X 12"	3	3/16 X 3/16 X 12"	3/32 X 5/16	207	332X31WK
			1/16 X 3/8	211	116X37WK
1/4 X 1/8	3	1/4 X 1/8	3/32 X 3/8	212	332X37WK
1/4 X 3/16	3	1/4 X 3/16	1/8 X 3/8	213	18X37WK
1/4 X 1/4	3	1/4 X 1/4	1/16 X 1/2	1	116X50WK
			3/32 X 1/2	2	332X50WK
5/16 X 3/16	3	5/16 X 3/16	1/8 X 1/2	3	18X50WK
5/16 X 1/4	3	5/16 X 1/4	3/32 X 5/8	4	332X62WK
5/16 X 5/16	3	5/16 X 5/16	1/8 X 5/8	5	18X62WK
			5/32 X 5/8	6	532X62WK
3/8 X 3/16	3	3/8 X 3/16	3/16 X 5/8	61	316X62WK
3/8 X 1/4	3	3/8 X 1/4	1/8 X 3/4	7	18X75WK
3/8 X 5/16	3	3/8 X 5/16	5/32 X 3/4	8	532X75WK
3/8 X 3/8	3	3/8 X 3/8	3/16 X 3/4	9	316X75WK
7/16 X 7/16	3	7/16 X 7/16			
1/2 X 1/4	3	1/2 X 1/4	1/4 X 3/4	91	14X75WK
1/2 X 5/16	3	1/2 X 5/16	5/32 X 7/8	10	532X87WK
1/2 X 3/8	3	1/2 X 3/8	3/16 X 7/8	11	316X87WK
1/2 X 7/16	3	1/2 X 7/16	7/32 X 7/8	12	732X87WK
1/2 X 1/2	3	1/2 X 1/2			
9/16 X 9/16	3	9/16 X 9/16	1/4 X 7/8	A	14X87WK
			3/16 X 1	13	316X100WK
5/8 X 5/16	3	5/8 X 5/16	7/32 X 1	14	732X100WK
5/8 X 3/8	3	5/8 X 3/8	1/4 X 1	15	14X100WK
5/8 X 1/2	3	5/8 X 1/2			
5/8 X 5/8	3	5/8 X 5/8	5/16 X 1	B	516X100WK
			3/8 X 1	152	38X100WK
			3/16 X 1 1/8	16	316X112WK
			7/32 X 1 1/8	17	732X112WK
3/4 X 3/4	3	3/4 X 3/4			
7/8 X 7/8	3	7/8 X 7/8	1/4 X 1 1/8	18	14X112WK
1 X 1 X 12"	3	1 X 1 X 12"	5/16 X 1 1/8	C	516X112WK
			3/16 X 1 1/4	19	316X125WK
			7/32 X 1 1/4	20	732X125WK
			1/4 X 1 1/4	21	14X125WK
			5/16 X 1 1/4	D	516X125WK
			3/8 X 1 1/4	E	38X125WK
			1/4 X 1 3/8	22	14X137WK
			5/16 X 1 3/8	23	516X137WK
			3/8 X 1 3/8	F	38X137WK
			1/4 X 1 1/2	24	14X150WK
			5/16 X 1 1/2	25	516X150WK
			3/8 X 1 1/2	G	38X150WK
			1/4 X 2 1/8	127	14X212WK
				129	38X212WK
				RX	14X275WK
				TX	38X275WK



# O-RINGS, QUAD RINGS    TEFLON BACK-UP WASHERS & VITON O-RINGS



INSIDE DIAMETER	OUTSIDE DIAMETER	O-RINGS	QUAD RINGS	TEFLON WASHERS	VITON O-RINGS	PART NO.
1/8	1/4	8OR	8QR	8BW	VOR	XXX006
5/32	9/32	8OR	8QR	8BW	VOR	XXX007
7/32	11/32	8OR	8QR	8BW	VOR	XXX009
1/4	3/8	8OR	8QR	8BW	VOR	XXX010
5/16	7/16	8OR	8QR	8BW	VOR	XXX011
3/8	1/2	8OR	8QR	8BW	VOR	XXX012
7/16	9/16	8OR	8QR	8BW	VOR	XXX013
1/2	5/8	8OR	8QR	8BW	VOR	XXX014
9/16	11/16	8OR	8QR	8BW	VOR	XXX015
5/8	3/4	8OR	8QR	8BW	VOR	XXX016
11/16	13/16	8OR	8QR	8BW	VOR	XXX017
3/4	7/8	8OR	8QR	8BW	VOR	XXX018
13/16	15/16	8OR	8QR	8BW	VOR	XXX019
7/8	1	8OR	8QR	8BW	VOR	XXX020
15/16	1 1/16	8OR	8QR	8BW	VOR	XXX021
1	1 1/8	8OR	8QR	8BW	VOR	XXX022
1 3/16	1 5/16	8OR	8QR	8BW	VOR	XXX025
1 3/8	1 1/2	8OR	8QR	8BW	VOR	XXX028
1/4	7/16	8OR	8QR	8BW	VOR	XXX108
3/8	9/16	8OR	8QR	8BW	VOR	XXX110
7/16	5/8	8OR	8QR	8BW	VOR	XXX111
1/2	11/16	8OR	8QR	8BW	VOR	XXX112
9/16	3/4	8OR	8QR	8BW	VOR	XXX113
5/8	13/16	8OR	8QR	8BW	VOR	XXX114
11/16	7/8	8OR	8QR	8BW	VOR	XXX115
3/4	15/16	8OR	8QR	8BW	VOR	XXX116
13/16	1	8OR	8QR	8BW	VOR	XXX117
7/8	1 1/16	8OR	8QR	8BW	VOR	XXX118
15/16	1 1/8	8OR	8QR	8BW	VOR	XXX119
1	1 3/16	8OR	8QR	8BW	VOR	XXX120
1 1/16	1 1/4	8OR	8QR	8BW	VOR	XXX121
1 1/8	1 5/16	8OR	8QR	8BW	VOR	XXX122
1 3/16	1 3/8	8OR	8QR	8BW	VOR	XXX123
1 1/4	1 7/16	8OR	8QR	8BW	VOR	XXX124
1 5/16	1 1/2	8OR	8QR	8BW	VOR	XXX125
1 3/8	1 9/16	8OR	8QR	8BW	VOR	XXX126
1 7/16	1 5/8	8OR	8QR	8BW	VOR	XXX127
1 1/2	1 11/16	8OR	8QR	8BW	VOR	XXX128
1 5/8	1 13/16	8OR	8QR	8BW	VOR	XXX130
2 1/16	2 1/4	8OR	8QR	8BW	VOR	XXX137
2 3/16	2 3/8	8OR	8QR	8BW	VOR	XXX139
2 3/4	2 15/16	8OR	8QR	8BW	VOR	XXX148

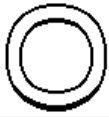

# O-RINGS, QUAD RINGS, TEFLON BACK-UP WASHERS & VITON O-RINGS



INSIDE DIAMETER	OUTSIDE DIAMETER	O-RINGS	QUAD RINGS	TEFLON WASHERS	VITON O-RINGS	PART NO.
1/4	1/2	8OR	8QR	8BW	VOR	XXX202
3/4	1	8OR	8QR	8BW	VOR	XXX210
1 3/16	1 1/16	8OR	8QR	8BW	VOR	XXX211
7/8	1 1/8	8OR	8QR	8BW	VOR	XXX212
15/16	1 3/16	8OR	8QR	8BW	VOR	XXX213
1	1 1/4	8OR	8QR	8BW	VOR	XXX214
1 1/16	1 5/16	8OR	8QR	8BW	VOR	XXX215
1 1/8	1 3/8	8OR	8QR	8BW	VOR	XXX216
1 3/16	1 7/16	8OR	8QR	8BW	VOR	XXX217
1 1/4	1 1/2	8OR	8QR	8BW	VOR	XXX218
1 5/16	1 9/16	8OR	8QR	8BW	VOR	XXX219
1 3/8	1 5/8	8OR	8QR	8BW	VOR	XXX220
1 7/16	1 11/16	8OR	8QR	8BW	VOR	XXX221
1 1/2	1 3/4	8OR	8QR	8BW	VOR	XXX222
1 5/8	1 7/8	8OR	8QR	8BW	VOR	XXX223
1 3/4	2	8OR	8QR	8BW	VOR	XXX224
1 7/8	2 1/8	8OR	8QR	8BW	VOR	XXX225
2	2 1/4	8OR	8QR	8BW	VOR	XXX226
2 1/4	2 1/2	8OR	8QR	8BW	VOR	XXX228
2 1/2	2 3/4	8OR	8QR	8BW	VOR	XXX230
2 3/4	3	8OR	8QR	8BW	VOR	XXX232
3	3 1/4	8OR	8QR	8BW	VOR	XXX234
3 1/8	3 3/8	8OR	8QR	8BW	VOR	XXX235
3 1/4	3 1/2	8OR	8QR	8BW	VOR	XXX236
3 1/2	3 3/4	8OR	8QR	8BW	VOR	XXX238
3 5/8	3 7/8	8OR	8QR	8BW	VOR	XXX239
3 3/4	4	8OR	8QR	8BW	VOR	XXX240
4	4 1/4	8OR	8QR	8BW	VOR	XXX242
4 1/4	4 1/2	8OR	8QR	8BW	VOR	XXX244
4 1/2	4 3/4	8OR	8QR	8BW	VOR	XXX246
4 7/8	5 1/8	8OR	8QR	8BW	VOR	XXX249
5	5 1/4	8OR	8QR	8BW	VOR	XXX250
5 1/2	5 3/4	8OR	8QR	8BW	VOR	XXX254
5 5/8	5 7/8	8OR	8QR	8BW	VOR	XXX255
5 7/8	6 1/8	8OR	8QR	8BW	VOR	XXX257
6 1/2	6 3/4	8OR	8QR	8BW	VOR	XXX260
6 3/4	7	8OR	8QR	8BW	VOR	XXX261
7	7 1/4	8OR	8QR	8BW	VOR	XXX262
7 1/2	7 3/4	8OR	8QR	8BW	VOR	XXX264
8 1/2	8 3/4	8OR	8QR	8BW	VOR	XXX268
1 5/8	2	8OR	8QR	8BW	VOR	XXX326
2	2 3/8	8OR	8QR	8BW	VOR	XXX329
2 1/8	2 1/2	8OR	8QR	8BW	VOR	XXX330
2 1/2	2 7/8	8OR	8QR	8BW	VOR	XXX333
2 7/8	3 1/4	8OR	8QR	8BW	VOR	XXX336



# NOTES

# NOTES

# NOTES

# BRASS FITTINGS & VALVES

## SAE FLARE 45 DEGREE FITTINGS

SAE FLARE 45 DEG COPPER GASKET	TUBE SIZE	PART #
		3/16
	1/4	2GF-4
	5/16	2GF-5
	3/8	2GF-6
	1/2	2GF-8
	5/8	2GF-10
	3/4	2GF-12

SAE FLARE 45 DEG SEAL BONNET	TUBE SIZE	PART #
		3/16
	1/4	3GF-4
	5/16	3GF-5
	3/8	3GF-6
	1/2	3GF-8
	5/8	3GF-10
	3/4	3GF-12

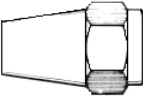
SAE FLARE 45 DEG LONG NUT	TUBE SIZE	PART #
		1/8
	3/16	41FL-3
	1/4	41FL-4
	5/16	41FL-5
	3/8	41FL-6
	1/2	41FL-8
	5/8	41FL-10
	3/4	41FL-12

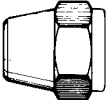
SAE FLARE 45 DEG SHORT NUT	TUBE SIZE	PART #
		1/8
	3/16	41FS-3
	1/4	41FS-4
	5/16	41FS-5
	3/8	41FS-6
	1/2	41FS-8
	5/8	41FS-10
	3/4	41FS-12

## SAE FLARE 45 DEGREE FITTINGS

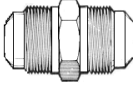
SAE FLARE 45 DEG UNION	TUBE SIZE	PART #
		1/8
	3/16	42F-3
	1/4	42F-4
	5/16	42F-5
	3/8	42F-6
	1/2	42F-8
	5/8	42F-10
	3/4	42F-12

SAE FLARE 45 DEG REDUCER	TUBE x TUBE	PART #
		1/4 X 3/8
	5/16 X 3/8	42F-5-6
	1/4 X 1/2	42F-4-8
	3/8 X 1/2	42F-6-8
	3/8 X 5/8	42F-6-10
	1/2 X 5/8	42F-8-10

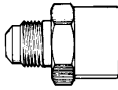
SAE FLARE 45 DEG FEMALE CONNECTOR	TUBE x FPT	PART #
		1/8 x 1/8
	3/16 x 1/8	46F-3-2
	1/4 x 1/8	46F-4-2
	1/4 x 1/4	46F-4-4
	1/4 x 3/8	46F-4-6
	5/16 x 1/8	46F-5-2
	5/16 x 1/4	46F-5-4
	3/8 x 1/8	46F-6-2
	3/8 x 1/4	46F-6-4
	3/8 x 3/8	46F-6-6
	3/8 x 1/2	46F-6-8
	1/2 x 1/4	46F-8-4
	1/2 x 3/8	46F-8-6
	1/2 x 1/2	46F-8-8
	1/2 x 3/4	46F-8-12
	5/8 x 3/8	46F-10-6
	5/8 x 1/2	46F-10-8
	5/8 x 3/4	46F-10-12

# BRASS FITTINGS & VALVES

## SAE 45 DEGREE FITTINGS

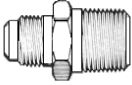
SAE FLARE 45 DEG MALE CONNECTOR	TUBE x TUBE	PART #
		1/8 x 1/8
	3/16 x 1/8	48F-3-2
	1/4 x 1/8	48F-4-2
	1/4 x 1/4	48F-4-4
	1/4 x 3/8	48F-4-6
	5/16 x 1/8	48F-5-2
	5/16 x 1/4	48F-5-4
	3/8 x 1/8	48F-6-2
	3/8 x 1/4	48F-6-4
	3/8 x 3/8	48F-6-6
	3/8 x 1/2	48F-6-8
	1/2 x 1/4	48F-8-4
	1/2 x 3/8	48F-8-6
	1/2 x 1/2	48F-8-8
	1/2 x 3/4	48F-8-12
	5/8 x 3/8	48F-10-6
	5/8 x 1/2	48F-10-8
	5/8 x 3/4	48F-10-12

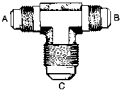
SAE FLARE 45 DEG UNION TEE	TUBE SIZE	PART #
		1/8
	3/16	144F-3
	1/4	144F-4
	5/16	144F-5
	3/8	144F-6
	1/2	144F-8
	5/8	144F-10

SAE FLARE 45 DEG MALE BRANCH TEE	TUBE x MPT	PART #
		1/8 x 1/8
	1/4 x 1/8	145F-4-2
	1/4 x 1/4	145F-4-4
	5/16 x 1/4	145F-5-4
	3/8 x 1/4	145F-6-4
	3/8 x 3/8	145F-6-6
	3/8 x 1/2	145F-6-8
	1/2 x 3/8	145F-8-6
	1/2 x 1/2	145F-8-8
	5/8 x 1/2	145F-10-8

## SAE 45 DEGREE FITTINGS

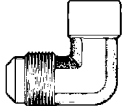
SAE FLARE 45 DEG FEMALE ELBOW	TUBE x FPT	PART #
		1/4 x 1/8
	1/4 x 1/4	150F-4-4
	1/4 x 3/8	150F-4-6
	5/16 x 1/4	150F-5-4
	3/8 x 1/8	150F-6-2
	3/8 x 1/4	150F-6-4
	3/8 x 3/8	150F-6-6
	3/8 x 1/2	150F-6-8
	1/2 x 3/8	150F-8-6
	1/2 x 1/2	150F-8-8
	1/2 x 3/4	150F-8-12
	5/8 x 1/2	150F-10-8
	5/8 x 3/4	150F-10-12

SAE FLARE 45 DEG MALE ELBOW	TUBE x MPT	PART #
		1/8 x 1/8
	3/16 x 1/8	149F-3-2
	1/4 x 1/8	149F-4-2
	1/4 x 1/4	149F-4-4
	1/4 x 3/8	149F-4-6
	5/16 x 1/8	149F-5-2
	5/16 x 1/4	149F-5-4
	5/16 x 3/8	149F-5-6
	3/8 x 1/8	149F-6-2
	3/8 x 1/4	149F-6-4
	3/8 x 3/8	149F-6-6
	3/8 x 1/2	149F-6-8
	1/2 x 1/4	149F-8-4
	1/2 x 3/8	149F-8-6
	1/2 x 1/2	149F-8-8
	1/2 x 3/4	149F-8-12
	5/8 x 3/8	149F-10-6
	5/8 x 1/2	149F-10-8
	5/8 x 3/4	149F-10-12
	3/4 x 1/2	149F-12-8
	3/4 x 3/4	149F-12-12

SAE FLARE 45 DEG FEM UNION	TUBE SIZE	PART #
		1/4
	3/8	660F-6
	1/2	660F-8

UNLIMITED SUPPLIES

# BRASS FITTINGS & VALVES

## SAE FLARE 45 DEGREE FITTINGS

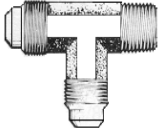
<b>SAE FLARE 45 DEG MALE RUN TEE</b>  	TUBE x MPT	PART #
	1/4 x 1/8	151F-4-2
	1/4 x 1/4	151F-4-4
	5/16 x 1/4	151F-5-4
	3/8 x 1/4	151F-6-4
	3/8 x 3/8	151F-6-6
	3/8 x 1/2	151F-6-8
	1/2 x 3/8	151F-8-6
	1/2 x 1/2	151F-8-8
	5/8 x 1/2	151F-10-8

<b>SAE FLARE 45 DEG UNION ELBOW</b>  	TUBE SIZE	PART #
	1/8	155F-2
	3/16	155F-3
	1/4	155F-4
	5/16	155F-5
	3/8	155F-6
	1/2	155F-8
	5/8	155F-10
	3/4	155F-12

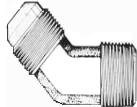
<b>SAE FLARE 45 DEG MALE 45D ELBOW</b>  	TUBE x MPT	PART #
	1/4 x 1/8	159F-4-2
	1/4 x 1/4	159F-4-4
	5/16 x 1/8	159F-5-2
	5/16 x 1/4	159F-5-4
	3/8 x 1/4	159F-6-4
	3/8 x 3/8	159F-6-6
	1/2 x 3/8	159F-8-6
	1/2 x 1/2	159F-8-8
	5/8 x 3/8	159F-10-6
	5/8 x 1/2	159F-10-8
	3/4 x 1/2	159F-12-10

## SAE FLARE 45 DEGREE FITTINGS

<b>SAE FLARE 45 DEG CAP NUT</b>  	TUBE x FPT	PART #
	3/16	640F-3
	1/4	640F-4
	5/16	640F-5
	3/8	640F-6
	1/2	640F-8
	5/8	640F-10

<b>SAE FLARE 45 DEG MALE - FEMREDUCER</b>  	M FLARE x F FLARE	PART #
	1/4 x 3/8	661F-4-6
	1/4 x 1/2	661F-4-8
	3/8 x 1/4	661F-6-4
	3/8 x 1/2	661F-6-8
	1/2 x 3/8	661F-8-6
	1/2 x 5/8	661F-8-10
5/8 x 1/2	661F-10-8	

<b>SAE FLARE 45 DEG FEM FLARE X MALE PIPE</b>  	F FLARE x MPT	PART #
	1/4 x 1/8	664F-4-2
	1/4 x 1/4	664F-4-4
	3/8 x 1/4	664F-6-6
	1/2 x 3/8	664F-8-6

<b>SAE FLARE 45 DEG FLARED SEAL PLUG</b>  	TUBE x MPT	PART #
	1/4	639F-4
	5/16	639F-5
	3/8	639F-6
	1/2	639F-8
	5/8	639F-10

# BRASS FITTINGS & VALVES

## INVERTED FLARE FITTINGS

INV FLARE NUT 	TUBE SIZE	PART #
	1/8	41IF-2
3/16	41IF-3	
1/4	41IF-4	
5/16	41IF-5	
3/8	41IF-6	
1/2	41IF-8	

INV FLARE NUT STEEL 	TUBE SIZE	PART #
	1/8	41IFS-2
3/16	41IFS-3	
1/4	41IFS-4	
5/16	41IFS-5	
3/8	41IFS-6	
1/2	41IFS-8	
5/8	41IFS-10	
3/4	41IFS-12	

INV FLARE MALE CONNECTOR 	TUBE x MPT	PART #
	1/8 x 1/8	48IF-2-2
3/16 x 1/8	48IF-3-2	
1/4 x 1/8	48IF-4-2	
1/4 x 1/4	48IF-4-4	
5/16 x 1/8	48IF-5-2	
5/16 x 1/4	48IF-5-4	
3/8 x 1/8	48IF-6-2	
3/8 x 1/4	48IF-6-4	
3/8 x 3/8	48IF-6-6	
1/2 x 1/4	48IF-8-4	
1/2 x 3/8	48IF-8-6	
1/2 x 1/2	48IF-8-8	
5/8 x 3/8	48IF-10-6	
5/8 x 1/2	48IF-10-8	

## INVERTED FLARE FITTINGS

INV FLARE UNION 	TUBE SIZE	PART #
	1/8	42IF-2
3/16	42IF-3	
1/4	42IF-4	
5/16	42IF-5	
3/8	42IF-6	
1/2	42IF-8	
5/8	42IF-10	

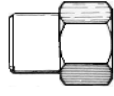
INV FLARE FEMALE CONNECTOR 	F FLARE x FPT	PART #
	3/16 x 1/8	46IF-3-2
1/4 x 1/8	46IF-4-2	
5/16 x 1/8	46IF-5-2	
3/8 x 1/4	46IF-6-4	
1/2 x 3/8	46IF-8-6	

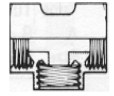
INV FLARE UNION TEE 	TUBE SIZE	PART #
	3/16	244IF-3
1/4	244IF-4	
5/16	244IF-5	
3/8	244IF-6	
1/2	244IF-8	

INV FLARE FEMALE ELBOW 	TUBE x FPT	PART #
	1/4 x 1/8	250IF-4-2
5/16 x 1/8	250IF-5-2	
3/8 x 1/4	250IF-6-4	

INV FLARE MALE RUN TEE 	TUBE x MPT	PART #
	3/16 x 1/8	251IF-3-2
5/16 x 1/8	251IF-5-2	
3/8 x 1/4	251IF-6-4	

# BRASS FITTINGS & VALVES

## INVERTED FLARE FITTINGS

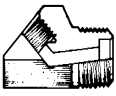
INV FLARE 45 DEG MALE ELBOW  	TUBE x MPT	PART #
	3/16 x 1/8	259IF-3-2
1/4 x 1/8	259IF-4-2	
5/16 x 1/8	259IF-5-2	
5/16 x 1/4	259IF-5-4	
3/8 x 1/4	259IF-6-4	
1/2 x 3/8	259IF-8-6	
5/8 x 1/2	259IF-10-8	

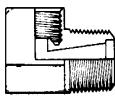
INV FLARE MALE ELBOW  	TUBE x MPT	PART #
	1/8 x 1/8	249IF-2-2
3/16 x 1/8	249IF-3-2	
1/4 x 1/8	249IF-4-2	
1/4 x 1/4	249IF-4-4	
5/16 x 1/8	249IF-5-2	
5/16 x 1/4	249IF-5-4	
3/8 x 1/8	249IF-6-2	
3/8 x 1/4	249IF-6-4	
3/8 x 3/8	249IF-6-6	
1/2 x 1/4	249IF-8-4	
1/2 x 3/8	249IF-8-6	
1/2 x 1/2	249IF-8-8	
5/8 x 3/8	249IF-10-6	
5/8 x 1/2	249IF-10-8	

## COPPER AIR BRAKE FITTINGS

AIR BRAKE SLEEVE  	TUBE SIZE	PART #
	1/4	60AB-4
3/8	60AB-6	
1/2	60AB-8	
5/8	60AB-10	
3/4	60AB-12	
1	60AB-16	

AIR BRAKE NUT  	TUBE SIZE	PART #
	1/4	61AB-4
3/8	61AB-6	
1/2	61AB-8	
5/8	61AB-10	
3/4	61AB-12	
1	61AB-16	

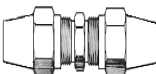
AIR BRAKE UNION  	TUBE SIZE	PART #
	1/4	62AB-4
3/8	62AB-6	
1/2	62AB-8	
5/8	62AB-10	
3/4	62AB-12	

AIR BRAKE BULKHEAD UNION  	TUBE SIZE	PART #
	1/4	62ABH-4
3/8	62ABH-6	
1/2	62ABH-8	
5/8	62ABH-10	
3/4	62ABH-12	

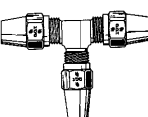
AIR BRAKE UNION TEE  	TUBE SIZE	PART #
	1/4	264AB-4
3/8	264AB-6	
1/2	264AB-8	
5/8	264AB-10	



# BRASS FITTINGS & VALVES

## COPPER AIR BRAKE FITTINGS

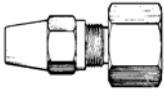
AIR BRAKE FEMALE CONNECTOR 	TUBE x FPT	PART #
	1/4 x 1/8	66AB-4-2
1/4 x 1/4	66AB-4-4	
3/8 x 1/8	66AB-6-2	
3/8 x 1/4	66AB-6-4	
3/8 x 3/8	66AB-6-6	
1/2 x 3/8	66AB-8-6	
5/8 x 3/8	66AB-10-6	
5/8 x 1/2	66AB-10-8	

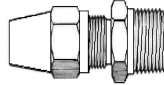
AIR BRAKE MALE CONNECTOR 	TUBE x MPT	PART #
	1/4 x 1/8	68AB-4-2
1/4 x 1/4	68AB-4-4	
1/4 x 3/8	68AB-4-6	
3/8 x 1/8	68AB-6-2	
3/8 x 1/4	68AB-6-4	
3/8 x 3/8	68AB-6-6	
3/8 x 1/2	68AB-6-8	
1/2 x 1/4	68AB-8-4	
1/2 x 3/8	68AB-8-6	
1/2 x 1/2	68AB-8-8	
5/8 x 3/8	68AB-10-6	
5/8 x 1/2	68AB-10-8	
3/4 x 1/2	68AB-12-8	
3/4 x 3/4	68AB-12-12	

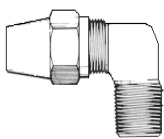
AIR BRAKE MALE ELBOW 	TUBE x MPT	PART #
	1/4 x 1/8	269AB-4-2
1/4 x 1/4	269AB-4-4	
1/4 x 3/8	269AB-4-6	
3/8 x 1/8	269AB-6-2	
3/8 x 1/4	269AB-6-4	
3/8 x 3/8	269AB-6-6	
3/8 x 1/2	269AB-6-8	
1/2 x 1/4	269AB-8-4	
1/2 x 3/8	269AB-8-6	
1/2 x 1/2	269AB-8-8	
5/8 x 3/8	269AB-10-6	
5/8 x 1/2	269AB-10-8	
3/4 x 1/2	269AB-12-8	

## COPPER AIR BRAKE FITTINGS

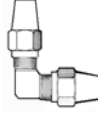
AIR BRAKE UNION ELBOW 	TUBE SIZE	PART #
	1/4	265AB-4
3/8	265AB-6	
1/2	265AB-8	
5/8	265AB-10	

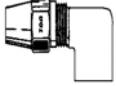
AIR BRAKE FEMALE ELBOW 	TUBE x FPT	PART #
	1/4 x 1/8	270AB-4-2
1/4 x 1/4	270AB-4-4	
3/8 x 1/8	270AB-6-2	
3/8 x 1/4	270AB-6-4	
3/8 x 3/8	270AB-6-6	
1/2 x 3/8	270AB-8-6	
5/8 x 3/8	270AB-10-6	
5/8 x 1/2	270AB-10-8	

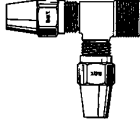
AIR BRAKE MALE RUN TEE 	TUBE x MPT	PART #
	1/4 x 1/8	271AB-4-2
1/4 x 1/4	271AB-4-4	
3/8 x 1/4	271AB-6-4	
3/8 x 3/8	271AB-6-6	
1/2 x 3/8	271AB-8-6	
1/2 x 1/2	271AB-8-8	
5/8 x 1/2	271AB-10-8	

AIR BRAKE MALE BRANCH TEE 	TUBE x MPT	PART #
	1/4 x 1/8	272AB-4-2
1/4 x 1/4	272AB-4-4	
3/8 x 1/8	272AB-6-2	
3/8 x 1/4	272AB-6-4	
3/8 x 3/8	272AB-6-6	
1/2 x 3/8	272AB-8-6	
1/2 x 1/2	272AB-8-8	
5/8 x 1/2	272AB-10-8	

# BRASS FITTINGS & VALVES

## COPPER AIR BRAKE FITTINGS

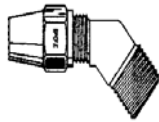
AIR BRAKE MALE 45 DEG ELBOW	TUBE x MPT	PART #
	1/4 x 1/8	279AB-4-2
	1/4 x 1/4	279AB-4-4
	3/8 x 1/8	279AB-6-2
	3/8 x 1/4	279AB-6-4
	3/8 x 3/8	279AB-6-6
	3/8 x 1/2	279AB-6-8
	1/2 x 3/8	279AB-8-6
	1/2 x 1/2	279AB-8-8
	5/8 x 3/8	279AB-10-6
	5/8 x 1/2	279AB-10-8
	3/4 x 1/2	279AB-12-8

## NTA AIR BRAKE FITTINGS

NTA BULKHEAD UNION	TUBE SIZE	PART #
	1/4	62NBH-4
	3/8	62NBH-6
	1/2	62NBH-8
	5/8	62NBH-10

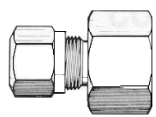
NTA FEMALE CONNECTOR	TUBE x FPT	PART #
	1/4 x 1/8	66NTA-4-2
	1/4 x 1/4	66NTA-4-4
	3/8 x 1/8	66NTA-6-2
	3/8 x 1/4	66NTA-6-4
	3/8 x 3/8	66NTA-6-6
	1/2 x 3/8	66NTA-8-6
	1/2 x 1/2	66NTA-8-8
	5/8 x 3/8	66NTA-10-6
	5/8 x 1/2	66NTA-10-8

## NTA AIR BRAKE FITTINGS

NTA SLEEVE	TUBE SIZE	PART #
	3/16	60NTA-3
	1/4	60NTA-4
	3/8	60NTA-6
	1/2	60NTA-8
	5/8	60NTA-10
	3/4	60NTA-12

NTA NUT	TUBE SIZE	PART #
	3/16	61NTA-3
	1/4	61NTA-4
	3/8	61NTA-6
	1/2	61NTA-8
	5/8	61NTA-10
	3/4	61NTA-12

AIR BRAKE UNION	TUBE SIZE	PART #
	1/4	62NTA-4
	3/8	62NTA-6
	1/2	62NTA-8
	5/8	62NTA-10
	3/4	62NTA-12

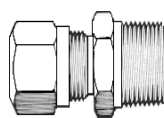
NTA MALE CONNECTOR	TUBE x MPT	PART #
	1/4 x 1/8	68NTA-4-2
	1/4 x 1/4	68NTA-4-4
	1/4 x 3/8	68NTA-4-6
	3/8 x 1/8	68NTA-6-2
	3/8 x 1/4	68NTA-6-4
	3/8 x 3/8	68NTA-6-6
	3/8 x 1/2	68NTA-6-8
	1/2 x 1/4	68NTA-8-4
	1/2 x 3/8	68NTA-8-6
	1/2 x 1/2	68NTA-8-8
	5/8 x 3/8	68NTA-10-6
	5/8 x 1/2	68NTA-10-8
	3/4 x 1/2	68NTA-12-8
	3/4 x 3/4	68NTA-12-10

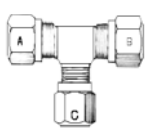
NTA UNION TEE	TUBE SIZE	PART #
	1/4	264NTA-4
	3/8	264NTA-6
	1/2	264NTA-8
	5/8	264NTA-10

# BRASS FITTINGS & VALVES

## NTA AIR BRAKE FITTINGS

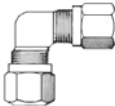
NTA UNION ELBOW 	TUBE SIZE	PART #
	1/4	265NTA-4
3/8	265NTA-6	
1/2	265NTA-8	
5/8	265NTA-10	

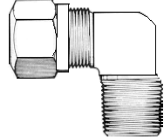
NTA MALE ELBOW 	TUBE x MPT	PART #
	1/4 x 1/8	269NTA-4-2
1/4 x 1/4	269NTA-4-4	
1/4 x 3/8	269NTA-4-6	
3/8 x 1/8	269NTA-6-2	
3/8 x 1/4	269NTA-6-4	
3/8 x 3/8	269NTA-6-6	
3/8 x 1/2	269NTA-6-8	
1/2 x 1/4	269NTA-8-4	
1/2 x 3/8	269NTA-8-6	
1/2 x 1/2	269NTA-8-8	
5/8 x 3/8	269NTA-10-6	
5/8 x 1/2	269NTA-10-8	
3/4 x 1/2	269NTA-12-8	

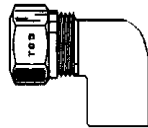
NTA FEMALE ELBOW 	TUBE x FPT	PART #
	1/4 x 1/8	270NTA-4-2
1/4 x 1/4	270NTA-4-4	
3/8 x 1/8	270NTA-6-2	
3/8 x 1/4	270NTA-6-4	
3/8 x 3/8	270NTA-6-6	
1/2 x 3/8	270NTA-8-6	
1/2 x 1/2	270NTA-8-8	
5/8 x 1/2	270NTA-10-8	

## NTA AIR BRAKE FITTINGS

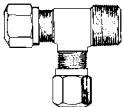
NTA MALE RUN TEE 	TUBE x MPT	PART #
	1/4 x 1/8	271NTA-4-2
1/4 x 1/4	271NTA-4-4	
3/8 x 1/4	271NTA-6-4	
3/8 x 3/8	271NTA-6-6	
1/2 x 3/8	271NTA-8-6	
1/2 x 1/2	271NTA-8-8	
5/8 x 1/2	271NTA-10-8	

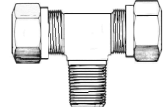
NTA MALE BRANCH TEE 	TUBE x MPT	PART #
	1/4 x 1/8	272NTA-4-2
1/4 x 1/4	272NTA-4-4	
3/8 x 1/8	272NTA-6-2	
3/8 x 1/4	272NTA-6-4	
3/8 x 3/8	272NTA-6-6	
1/2 x 1/4	272NTA-8-4	
1/2 x 3/8	272NTA-8-6	
1/2 x 1/2	272NTA-8-8	
5/8 x 1/2	272NTA-10-8	

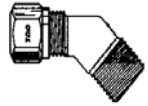
NTA 45 DEG MALE ELBOW 	TUBE x MPT	PART #
	1/4 x 1/8	279NTA-4-2
1/4 x 1/4	279NTA-4-4	
3/8 x 1/8	279NTA-6-2	
3/8 x 1/4	279NTA-6-4	
3/8 x 3/8	279NTA-6-6	
3/8 x 1/2	279NTA-6-8	
1/2 x 3/8	279NTA-8-6	
1/2 x 1/2	279NTA-8-8	
5/8 x 3/8	279NTA-10-6	
5/8 x 1/2	279NTA-10-8	
3/4 x 1/2	279NTA-12-8	

# BRASS FITTINGS & VALVES

## DOT PUSH-IN AIR BRAKE FITTINGS

DOT PUSH-IN UNION 	TUBE SIZE	PART #
	1/4	62PMT-4
3/8	62PMT-6	
1/2	62PMT-8	

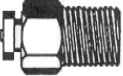
DOT PUSH-IN MALE CONN 	TUBE x MPT	PART #
	1/4 x 1/8	68PMT-4-2
1/4 x 1/4	68PMT-4-4	
3/8 x 1/8	68PMT-6-2	
3/8 x 1/4	68PMT-6-4	
3/8 x 3/8	68PMT-6-6	
3/8 x 1/2	68PMT-6-8	
1/2 x 1/4	68PMT-8-4	
1/2 x 3/8	68PMT-8-6	
1/2 x 1/2	68PMT-8-8	

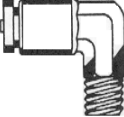
DOT PUSH-IN MALE ELBOW 90 DEG 	TUBE x MPT	PART #
	1/4 x 1/8	269PMT-4-2
1/4 x 1/4	269PMT-4-4	
3/8 x 1/8	269PMT-6-2	
3/8 x 1/4	269PMT-6-4	
3/8 x 3/8	269PMT-6-6	
3/8 x 1/2	269PMT-6-8	
1/2 x 1/4	269PMT-8-4	
1/2 x 3/8	269PMT-8-6	
1/2 x 1/2	269PMT-8-8	

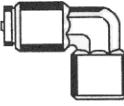
DOT PUSH-IN FEM ELBOW 90 DEG 	TUBE x FPT	PART #
	1/4 x 1/8	270PMT-4-2
1/4 x 1/4	270PMT-4-4	
3/8 x 1/4	270PMT-6-4	
3/8 x 3/8	270PMT-6-6	
1/2 x 1/2	270PMT-8-8	

## DOT PUSH-IN AIR BRAKE FITTINGS

DOT PUSH-IN ELBOW 	TUBE OD	PART #
	1/4	165PMT-4
3/8	165PMT-6	
1/2	165PMT-8	

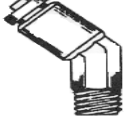
DOT PUSH-IN MALE ELBOW 45 DEG 	TUBE x MPT	PART #
	1/4 x 1/8	279PMT-4-2
1/4 x 1/4	279PMT-4-4	
3/8 x 1/8	279PMT-6-2	
3/8 x 1/4	279PMT-6-4	
3/8 x 3/8	279PMT-6-6	
5/8 x 1/2	279PMT-10-8	

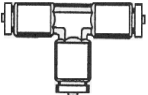
DOT PUSH-IN TEE 	TUBE	PART #
	1/4	264PMT-4
3/8	264PMT-6	
1/2	264PMT-8	

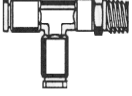
DOT PUSH-IN STREET TEE 	TUBE x MPT	PART #
	1/4 x 1/8	271PMT-4-2
1/4 x 1/4	271PMT-4-4	
3/8 x 1/4	271PMT-6-4	
3/8 x 3/8	271PMT-6-6	
1/2 x 3/8	271PMT-8-6	

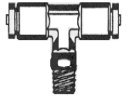
DOT PUSH-IN BRANCH TEE 	TUBE x MPT	PART #
	1/4 x 1/8	272PMT-4-2
1/4 x 1/4	272PMT-4-4	
3/8 x 1/4	272PMT-6-4	
3/8 x 3/8	272PMT-6-6	
1/2 x 3/8	272PMT-8-6	

# BRASS FITTINGS & VALVES

## RUBBER AIR BRAKE FITTINGS

<b>SLEEVE</b> 	TUBE SIZE	PART #
	3/8 1/2	60RB-6 60RB-8

<b>NUT</b> 	TUBE SIZE	PART #
	3/8 1/2	61RB-6 61RB-8

<b>NUT FOR SPRING</b> 	TUBE SIZE	PART #
	3/8 1/2	61RBSG-6 61RBSG-8

<b>UNION</b> 	TUBE SIZE	PART #
	3/8 1/2	62RB-6 62RB-8

<b>NUT WITH SPRING</b> 	TUBE SIZE	PART #
	3/8 1/2	67RBSG-6 67RBSG-8

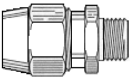
<b>MALE CONNECTOR</b> 	TUBE x MPT	PART #
	3/8 x 1/4 3/8 x 3/8 3/8 x 1/2 1/2 x 3/8 1/2 x 1/2	68RB-6-4 68RB-6-6 68RB-6-8 68RB-8-6 68RB-8-8

## RUBBER AIR BRAKE FITTINGS

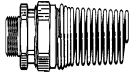
<b>MALE CONNECTOR W/SPRING</b> 	TUBE x MPT	PART #
	3/8 x 1/4 3/8 x 3/8 3/8 x 1/2 1/2 x 3/8 1/2 x 1/2	68RBSG-6-4 68RBSG-6-6 68RBSG-6-8 68RBSG-8-6 68RBSG-8-8

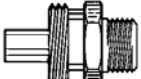
<b>MALE CONNECTOR BODY ONLY</b> 	TUBE x MPT	PART #
	3/8 x 1/4 3/8 x 3/8 3/8 x 1/2 1/2 x 3/8 1/2 x 1/2	68RB-6-4B 68RB-6-6B 68RB-6-8B 68RB-8-6B 68RB-8-8B

## BRASS FITTINGS & VALVES

### CAPTIVE SLEEVE COMP FITTINGS

NUT & SLEEVE ASSEMBLY  	TUBE SIZE	PART #
	1/8	61CA-2
3/16	61CA-3	
1/4	61CA-4	
5/16	61CA-5	
3/8	61CA-6	
1/2	61CA-8	
5/8	61CA-10	
3/4	61CA-12	
7/8	61CA-14	
1	61CA-16	

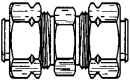
CAPTIVE SLEEVE UNION  	TUBE SIZE	PART #
	1/8	62CA-2
3/16	62CA-3	
1/4	62CA-4	
5/16	62CA-5	
3/8	62CA-6	
1/2	62CA-8	
5/8	62CA-10	
3/4	62CA-12	
7/8	62CA-14	

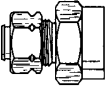
FEMALE CONNECTOR  	TUBE x FPT	PART #
	1/8 x 1/8	66CA-2-2
3/16 x 1/8	66CA-3-2	
3/16 x 1/4	66CA-3-4	
1/4 x 1/8	66CA-4-2	
1/4 x 1/4	66CA-4-4	
5/16 x 1/8	66CA-5-2	
5/16 x 1/4	66CA-5-4	
3/8 x 1/8	66CA-6-2	
3/8 x 1/4	66CA-6-4	
3/8 x 3/8	66CA-6-6	
3/8 x 1/2	66CA-6-8	
1/2 x 1/4	66CA-8-4	
1/2 x 3/8	66CA-8-6	
1/2 x 1/2	66CA-8-8	
5/8 x 1/2	66CA-10-8	

### CAPTIVE SLEEVE COMP FITTINGS

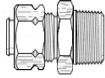
MALE CONNECTOR  	TUBE x MPT	PART #
	1/8 x 1/8	68CA-2-2
3/16 x 1/8	68CA-3-2	
3/16 x 1/4	68CA-3-4	
1/4 x 1/8	68CA-4-2	
1/4 x 1/4	68CA-4-4	
1/4 x 3/8	68CA-4-6	
5/16 x 1/8	68CA-5-2	
5/16 x 1/4	68CA-5-4	
3/8 x 1/8	68CA-6-2	
3/8 x 1/4	68CA-6-4	
3/8 x 3/8	68CA-6-6	
3/8 x 1/2	68CA-6-8	
1/2 x 1/4	68CA-8-4	
1/2 x 3/8	68CA-8-6	
1/2 x 1/2	68CA-8-8	
5/8 x 3/8	68CA-10-6	
5/8 x 1/2	68CA-10-8	
3/4 x 1/2	68CA-12-8	
3/4 x 3/4	68CA-12-10	

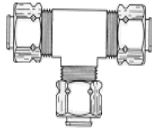
UNION TEE  	TUBE SIZE	PART #
	1/8	164CA-2
3/16	164CA-3	
1/4	164CA-4	
5/16	164CA-5	
3/8	164CA-6	
1/2	164CA-8	
5/8	164CA-10	

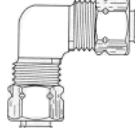
UNION ELBOW  	TUBE SIZE	PART #
	1/8	165CA-2
3/16	165CA-3	
1/4	165CA-4	
5/16	165CA-5	
3/8	165CA-6	
1/2	165CA-8	
5/8	165CA-10	

# BRASS FITTINGS & VALVES

## CAPTIVE SLEEVE COMP FITTINGS

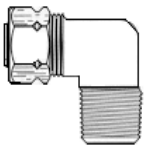
MALE ELBOW	TUBE x MPT	PART #
	1/8 x 1/8	169CA-2-2
	3/16 x 1/8	169CA-3-2
	3/16 x 1/4	169CA-3-4
	1/4 x 1/8	169CA-4-2
	1/4 x 1/4	169CA-4-4
	1/4 x 3/8	169CA-4-6
	5/16 x 1/8	169CA-5-2
	5/16 x 1/4	169CA-5-4
	3/8 x 1/8	169CA-6-2
	3/8 x 1/4	169CA-6-4
	3/8 x 3/8	169CA-6-6
	3/8 x 1/2	169CA-6-8
	1/2 x 1/4	169CA-8-4
	1/2 x 3/8	169CA-8-6
	1/2 x 1/2	169CA-8-8
	5/8 x 3/8	169CA-10-6
	5/8 x 1/2	169CA-10-8
3/4 x 1/2	169CA-12-8	
3/4 x 3/4	169CA-12-10	

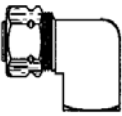
FEMALE ELBOW	TUBE x FPT	PART #
	1/8 x 1/8	170CA-2-2
	1/4 x 1/8	170CA-4-2
	1/4 x 1/4	170CA-4-4
	3/8 x 1/4	170CA-6-4
	3/8 x 3/8	170CA-6-6
	3/8 x 1/2	170CA-6-8
	1/2 x 3/8	170CA-8-6

MALE 45 DEG ELBOW	TUBE x MPT	PART #
	1/4 x 1/8	179CA-4-2
	1/4 x 1/4	179CA-4-4
	3/8 x 1/8	179CA-6-2
	3/8 x 1/4	179CA-6-4
	3/8 x 3/8	179CA-6-6
	1/2 x 3/8	179CA-8-6

## COMPRESSION FITTINGS

COMPRESSION SLEEVE	TUBE SIZE	PART #
	1/8	60C-2
	3/16	60C-3
	1/4	60C-4
	5/16	60C-5
	3/8	60C-6
	7/16	60C-7
	1/2	60C-8
	5/8	60C-10
	3/4	60C-12

COMPRESSION NUT	TUBE SIZE	PART #
	1/8	61C-2
	3/16	61C-3
	1/4	61C-4
	5/16	61C-5
	3/8	61C-6
	7/16	61C-7
	1/2	61C-8
	5/8	61C-10
	3/4	61C-12

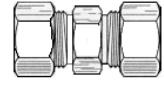
COMPRESSION UNION	TUBE SIZE	PART #
	1/8	62C-2
	3/16	62C-3
	1/4	62C-4
	5/16	62C-5
	3/8	62C-6
	7/16	62C-7
	1/2	62C-8
	5/8	62C-10
	3/4	62C-12

# BRASS FITTINGS & VALVES

## COMPRESSION FITTINGS

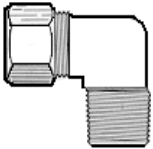
MALE ELBOW	TUBE x MPT	PART #
	1/8 x 1/8	169C-2-2
	3/16 x 1/8	169C-3-2
	3/16 x 1/4	169C-3-4
	1/4 x 1/8	169C-4-2
	1/4 x 1/4	169C-4-4
	1/4 x 3/8	169C-4-6
	5/16 x 1/8	169C-5-2
	5/16 x 1/4	169C-5-4
	3/8 x 1/8	169C-6-2
	3/8 x 1/4	169C-6-4
	3/8 x 3/8	169C-6-6
	3/8 x 1/2	169C-6-8
	1/2 x 1/4	169C-8-4
	1/2 x 3/8	169C-8-6
	1/2 x 1/2	169C-8-8
	5/8 x 3/8	169C-10-6
	5/8 x 1/2	169C-10-8
3/4 x 1/2	169C-12-8	
3/4 x 3/4	169C-12-10	

## COMPRESSION FITTINGS

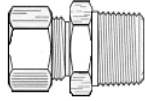
MALE CONNECTOR	TUBE x MPT	PART #
	1/8 x 1/8	68C-2-2
	3/16 x 1/8	68C-3-2
	3/16 x 1/4	68C-3-4
	1/4 x 1/8	68C-4-2
	1/4 x 1/4	68C-4-4
	1/4 x 3/8	68C-4-6
	5/16 x 1/8	68C-5-2
	5/16 x 1/4	68C-5-4
	3/8 x 1/8	68C-6-2
	3/8 x 1/4	68C-6-4
	3/8 x 3/8	68C-6-6
	3/8 x 1/2	68C-6-8
	1/2 x 1/4	68C-8-4
	1/2 x 3/8	68C-8-6
	1/2 x 1/2	68C-8-8
	5/8 x 3/8	68C-10-6
	5/8 x 1/2	68C-10-8
3/4 x 1/2	68C-12-8	
3/4 x 3/4	68C-12-10	

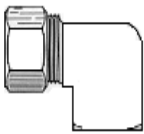
FEMALE ELBOW	TUBE x FPT	PART #
	1/8 x 1/8	170C-2-2
	1/4 x 1/8	170C-4-2
	1/4 x 1/4	170C-4-4
	3/8 x 1/4	170C-6-4
	3/8 x 3/8	170C-6-6
	3/8 x 1/2	170C-6-8
	1/2 x 3/8	170C-8-6

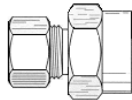
FEMALE CONNECTOR	TUBE x FPT	PART #
	1/8 x 1/8	66C-2-2
	3/16 x 1/8	66C-3-2
	3/16 x 1/4	66C-3-4
	1/4 x 1/8	66C-4-2
	1/4 x 1/4	66C-4-4
	5/16 x 1/8	66C-5-2
	5/16 x 1/4	66C-5-4
	3/8 x 1/8	66C-6-2
	3/8 x 1/4	66C-6-4
	3/8 x 3/8	66C-6-6
	3/8 x 1/2	66C-6-8
	1/2 x 1/4	66C-8-4
	1/2 x 3/8	66C-8-6
	1/2 x 1/2	66C-8-8
5/8 x 1/2	66C-10-8	

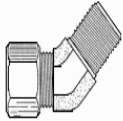
MALE 45 DEG ELBOW	TUBE x MPT	PART #
	1/4 x 1/8	179C-4-2
	1/4 x 1/4	179C-4-4
	3/8 x 1/8	179C-6-2
	3/8 x 1/4	179C-6-4
	3/8 x 3/8	179C-6-6
	1/2 x 3/8	179C-8-6



# BRASS FITTINGS & VALVES

## BRASS PIPE FITTINGS

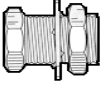
<b>ANCHOR COUPLING</b>  	FPT x STR THRD	PART #
	1/8 x 5/8-18	207ACBH-2
1/4 x 3/4-16	207ACBH-4	
3/8 x 1-14	207ACBH-6	
1/2 x 1 1/8-14	207ACBH-8	

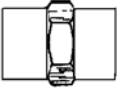
<b>HEX COUPLING</b>  	FPT	PART #
	1/8	207P-2
1/4	207P-4	
3/8	207P-6	
1/2	207P-8	

<b>REDUCER</b>  	FPT x FPT	PART #
	1/4 x 1/8	208P-4-2
3/8 x 1/4	208P-6-4	
1/2 x 1/4	208P-8-4	
1/2 x 3/8	208P-8-6	

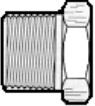
<b>HEX BUSHING</b>  	MPT x FPT	PART #
	1/4 x 1/8	209P-4-2
3/8 x 1/8	209P-6-2	
3/8 x 1/4	209P-6-4	
1/2 x 1/8	209P-8-2	
1/2 x 1/4	209P-8-4	
1/2 x 3/8	209P-8-6	
3/4 x 1/4	209P-12-4	
3/4 x 3/8	209P-12-6	
3/4 x 1/2	209P-12-8	

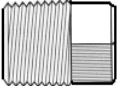
<b>SQ HEAD PLUG</b>  	MPT	PART #
	1/8	211P-2
1/4	211P-4	
3/8	211P-6	
1/2	211P-8	
3/4	211P-12	

## BRASS PIPE FITTINGS

<b>CAP</b>  	FPT	PART #
	1/8	213P-2
1/4	213P-4	
3/8	213P-6	
1/2	213P-8	

<b>NIPPLE</b>  	MPT x LENGTH	PART #
	18 x Close	215PN-2
1/8 x 1 1/2	215PNL-2-15	
1/8 x 2	215PNL-2-20	
1/8 x 2 1/2	215PNL-2-25	
1/8 x 3	215PNL-2-30	
1/8 x 3 1/2	215PNL-2-35	
1/4 x Close	215PN-4	
1/4 x 1 1/2	215PNL-4-15	
1/4 x 2	215PNL-4-20	
1/4 x 2 1/2	215PNL-4-25	
1/4 x 3	215PNL-4-30	
1/4 x 3 1/2	215PNL-4-35	
3/8 x Close	215PN-6	
3/8 x 1 1/2	215PNL-6-15	
3/8 x 2	215PNL-6-20	
3/8 x 2 1/2	215PNL-6-25	
3/8 x 3	215PNL-6-30	
3/8 x 3 1/2	215PNL-6-35	
1/2 x Close	215PN-8	
1/2 x 1 1/2	215PNL-8-15	
1/2 x 2	215PNL-8-20	
1/2 x 2 1/2	215PNL-8-25	
1/2 x 3	215PNL-8-30	
1/2 x 3 1/2	215PNL-8-35	

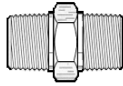
<b>HEX NIPPLE</b>  	MPT	PART #
	1/8	216P-2
1/4	216P-4	
3/8	216P-6	
1/2	216P-8	

# BRASS FITTINGS & VALVES

## BRASS PIPE FITTINGS

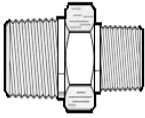
<b>MALE REDUCER</b> 	MPT x MPT	PART #
	1/4 x 1/8	216P-4-2
3/8 x 1/8	216P-6-2	
3/8 x 1/4	216P-6-4	
1/2 x 1/4	216P-8-4	
1/2 x 3/8	216P-8-6	
3/4 x 1/2	216P-12-8	

<b>HEX PLUG</b> 	MPT	PART #
	1/8	218P-2
1/4	218P-4	
3/8	218P-6	
1/2	218P-8	

<b>HEX PLUG COUNTERSUNK</b> 	MPT	PART #
	1/8	219P-2
1/4	219P-4	
3/8	219P-6	
1/2	219P-8	

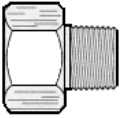
<b>ADAPTER</b> 	FPT x MPT	PART #
	1/8 x 1/8	222P-2-2
1/4 x 1/8	222P-4-2	
1/4 x 1/4	222P-4-4	
3/8 x 1/4	222P-6-4	
3/8 x 3/8	222P-6-6	
1/2 x 3/8	222P-8-6	
1/2 x 1/2	222P-8-8	
3/4 x 3/4	222P-12-12	

<b>SLOTTED PLUG</b> 	MPT	PART #
	1/8	220P-2
1/4	220P-4	
3/8	220P-6	

## BRASS PIPE FITTINGS

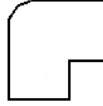
<b>90 DEG ELBOW</b> 	FPT	PART #
	1/8	2200P-2
1/4	2200P-4	
3/8	2200P-6	
1/2	2200P-8	

<b>90 DEG STREET ELBOW</b> 	FPT X MPT	PART #
	1/8 x 1/8	2202P-2-2
1/4 x 1/8	2202P-4-2	
1/4 x 1/4	2202P-4-4	
3/8 x 3/8	2202P-6-6	
1/2 x 1/2	2202P-8-8	

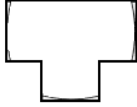
<b>TEE</b> 	FPT	PART #
	1/8	2203P-2
1/4	2203P-4	
3/8	2203P-6	
1/2	2203P-8	

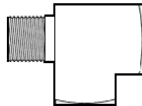
<b>STREET TEE</b> 	PIPE SIZE	PART #
	1/8	2225P-2
1/4	2225P-4	
3/8	2225P-6	
1/2	2225P-8	

<b>STREET ELBOW 45 DEG</b> 	FPT x MPT	PART #
	1/8	2214P-2-2
1/4	2214P-4-4	
3/8	2214P-6-6	
1/2	2214P-8-8	

# BRASS FITTINGS & VALVES

## STAYPUT HOSE BARB FITTINGS

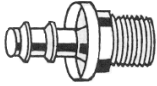
 STAYPUT BARB MALE CONN	HOSE x MPT	PART #
		1/4 x 1/8
	1/4 x 1/4	920CC
	1/4 x 3/8	920CE
	5/16 x 1/8	920D
	5/16 x 1/4	920DD
	3/8 x 1/8	920E
	3/8 x 1/4	920EE
	3/8 x 3/8	920EEE
	3/8 x 1/2	920EF
	1/2 x 1/4	920FC
	1/2 x 3/8	920F
	1/2 x 1/2	920FF
	1/2 x 3/4	920FJ
	5/8 x 3/8	920HE
	5/8 x 1/2	920H
	5/8 x 3/4	920HJ
	3/4 x 1/2	920JJ

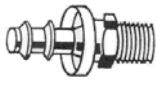
 STAYPUT BARB x INV FLARE MALE NUT	HOSE x IFM	PART #
		1/4 x 3/16
	1/4 x 1/4	905CC
	1/4 x 5/16	905CD
	5/16 x 1/4	905DC
	5/16 x 5/16	905DDD
	5/16 x 3/8	905DE
	3/8 x 5/16	905ED
	3/8 x 3/8	905EEE
	3/8 x 1/2	905EF
	1/2 x 3/8	905F
	1/2 x 1/2	905FF

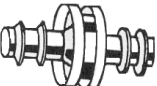
 STAYPUT BARB SPLICER	TUBE SIZE	PART #
		1/4
	5/16	922D
	3/8	922E
	1/2	922F
	5/8	922H

## STAYPUT HOSE BARB FITTINGS

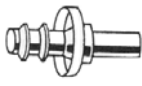
 STAYPUT BARB COMPRESSION SPLICER	HOSE x TUBE	PART #
		1/4 x 3/16
	1/4 x 1/4	922TCC
	1/4 x 5/16	922TCD
	5/16 x 5/16	922TDDD
	3/8 x 5/16	922TED
	3/8 x 3/8	922TEEE
	3/8 x 1/2	922TEF
	1/2 x 3/8	922TFE
	1/2 x 1/2	922TFF

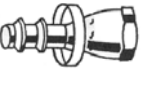
 STAYPUT BARB x SAE FEM SWIVEL NUT	HOSE x FEM SAE	PART #
		1/4 x 1/4
	1/4 x 5/16	940CD
	1/4 x 3/8	940CE
	5/16 x 5/16	940DDD
	5/16 x 3/8	940DE
	3/8 x 3/8	940EEE
	3/8 x 1/2	940EF
	1/2 x 3/8	940F
	1/2 x 1/2	940FF
	1/2 x 5/8	940FH
	5/8 x 1/2	940HF
	5/8 x 5/8	940HH
	3/4 x 3/4	940JJ

 STAYPUT BARB x SAE MALE	HOSE x MALE SAE	PART #
		1/4 x 1/4
	1/4 x 5/16	939CD
	1/4 x 3/8	939CE
	5/16 x 5/16	939DDD
	3/8 x 1/4	939EE
	3/8 x 5/16	939ED
	3/8 x 3/8	939EEE
	3/8 x 1/2	939EF
	1/2 x 1/2	939FF
	1/2 x 5/8	939FH
	5/8 x 1/2	939HF

# BRASS FITTINGS & VALVES

## STAYPUT HOSE BARB FITTINGS

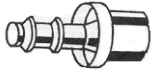
<b>STAYPUT BARB x FEM INV FLARE</b>  	HOSE x FEM IF	PART #
	1/4 x 3/16	900CB
1/4 x 1/4	900CC	
1/4 x 5/16	900CD	
5/16 x 5/16	900DDD	
3/8 x 5/16	900ED	
3/8 x 3/8	900EEE	
1/2 x 1/2	900FF	

<b>STAYPUT BARB x FEM PIPE</b>  	HOSE x FPT	PART #
	1/4 x 1/8	903CA
1/4 x 1/4	903CC	
1/4 x 3/8	903CE	
3/8 x 1/8	903E	
3/8 x 1/4	903EE	
3/8 x 3/8	903EEE	
1/2 x 3/8	903F	
1/2 x 1/2	903FF	

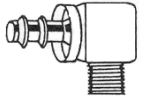
<b>STAYPUT BARB MALE ELBOW</b>  	HOSE x MPT	PART #
	5/16 x 1/8	929LD
5/16 x 1/4	929LDD	
3/8 x 1/8	929LE	
3/8 x 1/4	929LEE	

## AIR BRAKE HOSE

<b>NYLON DOT AIRBRAKE TUBING</b>  	TUBING	PART #
	5/32	M38900
1/8	M38950	
1/4	M38952	
3/8	M38960	
1/2	M38965	
5/8	M38970	
3/4	M38975	

<b>RUBBER DOT AIRBRAKE HOSE</b>	HOSE	PART #
	3/8	M38910
1/2	M38915	

<b>PUSH ON HOSE</b>	HOSE	PART #
	1/4	RH90C
3/8	RH90E	
1/2	RH90F	
5/8	RH90H	

# BRASS FITTINGS & VALVES

## VALVES

<b>MINI BALL VALVE</b> MPT X FPT 	SIZE	PART #
	1/8	MV608-2
1/4	MV608-4	
3/8	MV608-6	
1/2	MV608-8	

<b>MINI BALL VALVE</b> FPT X FPT 	SIZE	PART #
	1/8	MV609-2
1/4	MV609-4	
3/8	MV609-6	
1/2	MV609-8	

<b>TRUCK VALVE</b> HOSE X MPT 	HOSE x MPT	PART #
	3/8 x 3/8	V404P-6-6
5/8 x 3/8	V404P-10-6	

<b>SHUTOFF COCK</b> MPT x MPT 	SIZE	PART #
	1/8	V401P-2-2
1/4	V401P-4-4	
3/8	V401P-6-6	
1/2	V401P-8-8	

<b>SHUTOFF COCK</b> MPT x FPT 	SIZE	PART #
	1/8	V402P-2-2
1/4	V402P-4-4	
3/8	V402P-6-6	
1/2	V402P-8-8	

<b>EXTERNAL SEAT</b> DRAIN COCK 	SIZE	PART #
	1/8	DC604-2
1/4	DC604-4	
3/8	DC604-6	
1/2	DC604-8	

## GREASE FITTINGS

<b>STRAIGHT</b> SHORT 	SIZE	PART #
	1/8MPT	7000
1/4-28	7010	
1/4 MPT	7050	
5/16-24	7061	
3/8-24	7062	
6MM	8600	
8MM	8800	
10MM	8100	

<b>45 DEGREE</b> 	SIZE	PART #
	1/8MPT	7200
1/4-28	7210	
1/4 MPT	7350	
6MM	8645	
8MM	8845	
10MM	8104	

<b>90 DEGREE</b> 	SIZE	PART #
	1/8MPT	7400
1/4-28	7410	
6MM	8690	
8MM	8890	
10MM	8109	

<b>STRAIGHT</b> LONG 	SIZE	PART #
	1/8MPT	7003
1/4-28	7014	

<b>DRIVE TYPE</b> 	SIZE	PART #
	3/16	7033
1/4	7029	
5/16	7030	

# PIPE FITTINGS

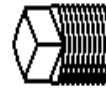
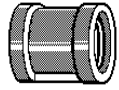

SIZE	CLOSED PIPE NIPPLE	PIPE COUPLING	45° ELBOW	90° ELBOW	SQUARE HEAD PLUG	HEX COUNTERSUNK PLUG
1/8	12CLPN	12CPL	12EL45	12EL90	12SHP	12HCP
1/4	25CLPN	25CPL	25EL45	25EL90	25SHP	25HCP
3/8	37CLPN	37CPL	37EL45	37EL90	37SHP	37HCP
1/2	50CLPN	50CPL	50EL45	50EL90	50SHP	50HCP
3/4	75CLPN	75CPL	75EL45	75EL90	75SHP	75HCP
1	100CLPN	100CPL	100EL45	100EL90	100SHP	100HCP
1 1/4	125CLPN	125CPL	125EL45	125EL90	125SHP	125HCP
1 1/2	150CLPN	150CPL	150EL45	150EL90	150SHP	150HCP
2	200CLPN	200CPL	200EL45	200EL90	200SHP	200HCP

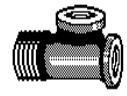
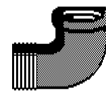

SIZE	PIPE CAP	PIPE CROSS	45° STREET ELBOW	90° STREET ELBOW	PIPE TEE	STREET TEE
1/8	12CAP	12CR	12SEL45	12SEL90	12T	12ST
1/4	25CAP	25CR	25SEL45	25SEL90	25T	25ST
3/8	37CAP	37CR	37SEL45	37SEL90	37T	37ST
1/2	50CAP	50CR	50SEL45	50SEL90	50T	50ST
3/4	75CAP	75CR	75SEL45	75SEL90	75T	75ST
1	100CAP	100CR	100SEL45	100SEL90	100T	100ST
1 1/4	125CAP	125CR	125SEL45	125SEL90	125T	125ST
1 1/2	150CAP	150CR	150SEL45	150SEL90	150T	150ST
2	200CAP	200CR	200SEL45	200SEL90	200T	200ST



# PIPE NIPPLES



SIZE	LENGTH					
	1 1/2	2	2 1/2	3	3 1/2	4
1/8	12X150PN	12X200PN	12X250PN	12X300PN	12X350PN	12X400PN
1/4	25X150PN	25X200PN	25X250PN	25X300PN	25X350PN	25X400PN
3/8	37X150PN	37X200PN	37X250PN	37X300PN	37X350PN	37X400PN
1/2	50X150PN	50X200PN	50X250PN	50X300PN	50X350PN	50X400PN
3/4	75X150PN	75X200PN	75X250PN	75X300PN	75X350PN	75X400PN
1	100X150PN	100X200PN	100X250PN	100X300PN	100X350PN	100X400PN
1 1/4	125X150PN	125X200PN	125X250PN	125X300PN	125X350PN	125X400PN
1 1/2	150X150PN	150X200PN	150X250PN	150X300PN	150X350PN	150X400PN
2	200X150PN	200X200PN	200X250PN	200X300PN	200X350PN	200X400PN

SIZE	LENGTH					
	4 1/2	5	5 1/2	6	6 1/2	7
1/8	12X450PN	12X500PN	12X550PN	12X600PN	12X650PN	12X700PN
1/4	25X450PN	25X500PN	25X550PN	25X600PN	25X650PN	25X700PN
3/8	37X450PN	37X500PN	37X550PN	37X600PN	37X650PN	37X700PN
1/2	50X450PN	50X500PN	50X550PN	50X600PN	50X650PN	50X700PN
3/4	75X450PN	75X500PN	75X550PN	75X600PN	75X650PN	75X700PN
1	100X450PN	100X500PN	100X550PN	100X600PN	100X650PN	100X700PN
1 1/4	125X450PN	125X500PN	125X550PN	125X600PN	125X650PN	125X700PN
1 1/2	150X450PN	150X500PN	150X550PN	150X600PN	150X650PN	150X700PN
2	200X450PN	200X500PN	200X550PN	200X600PN	200X650PN	200X700PN

UNLIMITED SUPPLIES

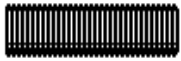

# THREADED ROD

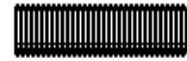

COARSE THREAD

FINE THREAD

SIZE x Ft	GRADE 2	B-7	GRADE 2	B-7
6-32 X 1	6C12TR2	6C12B7	6F12TR2	6F12B7
6-32 X 2	6C24TR2	6C24B7	6F24TR2	6F24B7
6-32 X 3	6C36TR2	6C36B7	6F36TR2	6F36B7
8-32 X 1	8C12TR2	8C12B7	8F12TR2	8F12B7
8-32 X 2	8C24TR2	8C24B7	8F24TR2	8F24B7
8-32 X 3	8C36TR2	8C36B7	8F36TR2	8F36B7
10-24 X 1	10C12TR2	10C12B7	10F12TR2	10F12B7
10-24 X 2	10C24TR2	10C24B7	10F24TR2	10F24B7
10-24 X 3	10C36TR2	10C36B7	10F36TR2	10F36B7
10-24 X 6	10C72TR2	10C7B7	10F72TR2	10F7B7
1/4-20 X 1	25C12TR2	25C12B7	25F12TR2	25F12B7
1/4-20 X 2	25C24TR2	25C24B7	25F24TR2	25F24B7
1/4-20 X 3	25C36TR2	25C36B7	25F36TR2	25F36B7
1/4-20 X 6	25C72TR2	25C72B7	25F72TR2	25F72B7
5/16-18 X 1	31C12TR2	31C12B7	31F12TR2	31F12B7
5/16-18 X 2	31C24TR2	31C24B7	31F24TR2	31F24B7
5/16-18 X 3	31C36TR2	31C36B7	31F36TR2	31F36B7
5/16-18 X 6	31C72TR2	31C72B7	31F72TR2	31F72B7
3/8-16 X 1	37C12TR2	37C12B7	37F12TR2	37F12B7
3/8-16 X 2	37C24TR2	37C24B7	37F24TR2	37F24B7
3/8-16 X 3	37C36TR2	37C36B7	37F36TR2	37F36B7
3/8-16 X 6	37C72TR2	37C72B7	37F72TR2	37F72B7
7/16-14 X 2	43C12TR2	43C12B7	43F12TR2	43F12B7
7/16-14 X 3	43C24TR2	43C24B7	43F24TR2	43F24B7
7/16-14 X 6	43C72TR2	43C72B7	43F72TR2	43F72B7
1/2-13 X 1	50C12TR2	50C12B7	50F12TR2	50F12B7
1/2-13 X 2	50C24TR2	50C24B7	50F24TR2	50F24B7
1/2-13 X 3	50C36TR2	50C36B7	50F36TR2	50F36B7
1/2-13 X 6	50C72TR2	50C72B7	50F72TR2	50F72B7
9/16-12 X 3	56C36TR2	56C36B7	56F36TR2	56F36B7
9/16-12 X 6	56C72TR2	56C72B7	56F72TR2	56F72B7
5/8-11 X 1	62C12TR2	62C12B7	62F12TR2	62F12B7
5/8-11 X 2	62C24TR2	62C24B7	62F24TR2	62F24B7
5/8-11 X 3	62C36TR2	62C36B7	62F36TR2	62F36B7
5/8-11 X 6	62C72TR2	62C7B7	62F72TR2	62F7B7
3/4-10 X 1	75C12TR2	75C12B7	75F12TR2	75F12B7
3/4-10 X 2	75C24TR2	75C24B7	75F24TR2	75F24B7
3/4-10 X 3	75C36TR2	75C36B7	75F36TR2	75F36B7
3/4-10 X 6	75C72TR2	75C72B7	75F72TR2	75F72B7
	87C24TR2			
7/8-9 X 2	87C36TR2	87C24B7	87F24TR2	87F24B7
7/8-9 X 3	87C72TR2	87C36B7	87F36TR2	87F36B7
7/8-9 X 6		87C72B7	87F72TR2	87F72B7
	100C24TR2			
1-8 X 2	100C36TR2	100C24B7	100F24TR2	100F24B7
1-8 X 3	100C72TR2	100C36B7	100F36TR2	100F36B7
1-8 X 6	100C120TR2	100C72B7	100F72TR2	100F72B7
1-8 X 10		100C120B7	100F120TR2	100F120B7



# HIGH SPEED STEEL & SUPER PREMIUM BOTTOM, PLUG AND TAPER TAPS

## HIGH SPEED STEEL TAPS

SIZE	BOTTOM (B)		PLUG (P)		TAPER (T)	
	COARSE	FINE	COARSE	FINE	COARSE	FINE
1/4	308-1/4-20B	308-1/4-28B	308-1/4-20P	308-1/4-28P	308-1/4-20T	308-1/4-28T
5/16	308-5/16-18B	308-5/16-24B	308-5/16-18P	308-5/16-24P	308-5/16-18T	308-5/16-24T
3/8	308-3/8-16B	308-3/8-24B	308-3/8-16P	308-3/8-24P	308-3/8-16T	308-3/8-24T
7/16	308-7/16-14B	308-7/16-20B	308-7/16-14P	308-7/16-20P	308-7/16-14T	308-7/16-20T
1/2	308-1/2-13B	308-1/2-20B	308-1/2-13P	308-1/2-20P	308-1/2-13T	308-1/2-20T
9/16	308-9/16-12B	308-9/16-18B	308-9/16-12P	308-9/16-18P	308-9/16-12T	308-9/16-18T
5/8	308-5/8-11B	308-5/8-18B	308-5/8-11P	308-5/8-18P	308-5/8-11T	308-5/8-18T
3/4	308-3/4-10B	308-3/4-16B	308-3/4-10P	308-3/4-16P	308-3/4-10T	308-3/4-16T
7/8	308-7/8-9B	308-7/8-14B	308-7/8-9P	308-7/8-14P	308-7/8-9T	308-7/8-14T
1	308-1-8B	308-1-14B	308-1-8P	308-1-14P	308-1-8T	308-1-14T

## SUPER PREMIUM TAPS

SIZE	BOTTOM (B)		PLUG (P)		TAPER (T)	
	COARSE	FINE	COARSE	FINE	COARSE	FINE
1/4	AG-1/4-20B	AG-1/4-28B	AG-1/4-20P	AG-1/4-28P	AG-1/4-20T	AG-1/4-28T
5/16	AG-5/16-18B	AG-5/16-24B	AG-5/16-18P	AG-5/16-24P	AG-5/16-18T	AG-5/16-24T
3/8	AG-3/8-16B	AG-3/8-24B	AG-3/8-16P	AG-3/8-24P	AG-3/8-16T	AG-3/8-24T
7/16	AG-7/16-14B	AG-7/16-20B	AG-7/16-14P	AG-7/16-20P	AG-7/16-14T	AG-7/16-20T
1/2	AG-1/2-13B	AG-1/2-20B	AG-1/2-13P	AG-1/2-20P	AG-1/2-13T	AG-1/2-20T
9/16	AG-9/16-12B	AG-9/16-18B	AG-9/16-12P	AG-9/16-18P	AG-9/16-12T	AG-9/16-18T
5/8	AG-5/8-11B	AG-5/8-18B	AG-5/8-11P	AG-5/8-18P	AG-5/8-11T	AG-5/8-18T
3/4	AG-3/4-10B	AG-3/4-16B	AG-3/4-10P	AG-3/4-16P	AG-3/4-10T	AG-3/4-16T
7/8	AG-7/8-9B	AG-7/8-14B	AG-7/8-9P	AG-7/8-14P	AG-7/8-9T	AG-7/8-14T
1	AG-1-8B	AG-1-14B	AG-1-8P	AG-1-14P	AG-1-8T	AG-1-14T

# HEAT SHRINK ELECTRICAL TERMINALS

(ORDER IN QUANTITIES OF 50 UNLESS OTHERWISE NOTED)

## BUTT CONNECTORS

	WIRE GAUGE	PART NO.
	22-18	516S
	16-14	514S
	12-10	510S
	16-14 X 22-18	KS56-16
	12-10 X 16-14	KS56-14

## SPADE CONNECTORS

	WIRE GAUGE	PART NO.
	22-18 X #10	21610S
	16-14 X #10	21410S
	12-10 X #10	21010S

## HEAT SHRINK TUBING

SIZE (I.D. X LENGTH)	PART NO.	QTY	
22-18 X 6"	280	10	
14-16 X 6"	281	10	
10-12 X 6"	282	10	
	1/8" X 12"	22102	10
	3/16" X 12"	22103	10
	1/4" X 12"	22104	10
	3/8" X 12"	22106	10
	1/2" X 12"	22108	10
	3/4" X 12"	22112	10
1" X 12"	22116	10	
<b>DOUBLE WALL</b>			
	22251	10	
1/8" X 6"	22252	10	
3/16" X 6"	22253	10	
1/4" X 6"			

## RING CONNECTORS

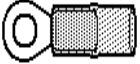
	WIRE GAUGE	PART NO.
	22-18 X #6	11606S
	22-18 X #8	11608S
	22-18 X #10	11610S
	22-18 X 1/4	11614S
	22-18 X 3/8	11638S
	16-14 X #6	11406S
	16-14 X #8	11408S
	16-14 X #10	11410S
	16-14 X 1/4	11414S
	16-14 X 5/16	114516S
	16-14 X 3/8	11438S
	12-10 X #6	11006S
	12-10 X #8	11008S
	12-10 X #10	11010S
	12-10 X 1/4	11014S
	12-10 X 3/8	11038S
12-10 X 1/2	11012S	

## PUSH-ON CONNECTORS

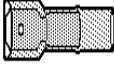
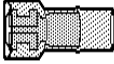
	WIRE GAUGE	PART NO.
	<b>MALE</b> 22-18	6618M-S
	16-14	6614M-S
	12-10	6610M-S
	<b>FEMALE</b> 22-18	6618F-S
	16-14	6614F-S
	12-10	6610F-S

# NYLON INSULATED ELECTRICAL TERMINALS

(ORDER IN QUANTITIES OF 50 UNLESS OTHERWISE NOTED)

## BUTT CONNECTORS

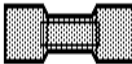
	WIRE GAUGE	PART NO.
	22-18	30760
	16-14	31760
	12-10	32760
	8	33560
	6	34560
	4	35560

## LARGE RING CONNECTORS

	WIRE GAUGE	PART NO.
	8 X #8	33500
	8 X #10	33501
	8 X 1/4	33502
	8 X 3/8	33504
	6 X #10	34500
	6 X 1/4	34501
	6 X 5/16	34502
	6 X 3/8	34503
	4 X #10	35505
	4 X 1/4	35500
	4 X 5/16	35501
	4 X 3/8	35502

## PUSH-ON CONNECTORS

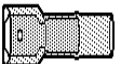
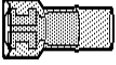
	WIRE GAUGE	PART NO.
	MALE 22-18	30712
	16-14	31712
	12-10	32714
	FEMALE 22-18	30713
	16-14	31713
	12-10	32715

## RING CONNECTORS

	WIRE GAUGE	PART NO.
	22-18 X #6	30701
	22-18 X #8	30702
	22-18 X #10	30703
	22-18 X 1/4	30704
	22-18 X 3/8	30706
	16-14 X #6	31701
	16-14 X #8	31702
	16-14 X #10	31703
	16-14 X 1/4	31704
	16-14 X 5/16	31705
	16-14 X 3/8	31706
	12-10 X #6	32700
	12-10 X #8	32701
	12-10 X #10	32702
	12-10 X 1/4	32703
	12-10 X 3/8	32705
	12-10 X 1/2	32706

## SPADE CONNECTORS

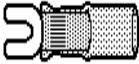
	WIRE GAUGE	PART NO.
	22-18 X #6	30723
	22-18 X #8	30724
	22-18 X #10	30725
	16-14 X #6	31723
	16-14 X #8	31724
	16-14 X #10	31725
	12-10 X #6	32723
	12-10 X #8	32724
	12-10 X #10	32725

# NON-INSULATED ELECTRICAL TERMINALS

(ORDER IN QUANTITIES OF 50 UNLESS OTHERWISE NOTED)

## BUTT CONNECTORS

	WIRE GAUGE	PART NO.
	22-18	30060
	16-14	31060
	12-10	32060

## RING CONNECTORS

	WIRE GAUGE	PART NO.
	22-18 X #6	30001
	22-18 X #8	30002
	22-18 X #10	30003
	22-18 X 1/4	30004
	22-18 X 3/8	30006
	16-14 X #6	31001
	16-14 X #8	31001
	16-14 X #10	31003
	16-14 X 1/4	31004
	16-14 X 5/16	31005
	16-14 X 3/8	31006
	12-10 X #6	32000
	12-10 X #8	32001
	12-10 X #10	32002
	12-10 X 1/4	32003
	12-10 X 3/8	32005
	12-10 X 1/2	32006

## LARGE RING CONNECTORS

	WIRE GAUGE	PART NO.
	8 X #8	33000
	8 X #10	33001
	8 X 1/4	33002
	8 X 3/8	33004
	6 X #10	34000
	6 X 1/4	34001
	6 X 5/16	34002
	6 X 3/8	34003
	4 X #10	35005
	4 X 1/4	35000
	4 X 5/16	35001
	4 X 3/8	35002

## SPADE CONNECTORS

	WIRE GAUGE	PART NO.
	22-18 X #6	30023
	22-18 X #8	30024
	22-18 X #10	30025
	16-14 X #6	31023
	16-14 X #8	31024
	16-14 X #10	31025
	12-10 X #6	32023
	12-10 X #8	32024
	12-10 X #10	32025

UNLIMITED SUPPLIES

# CARBIDE BURRS

	DIAMETER X FLUTE	PART NO.
<b>CYLINDRICAL</b>  	1/4 X 5/8	SA1
	5/16 X 3/4	SA2
	3/8 X 3/4	SA3
	7/16 X 1	SA4
	1/2 X 1	SA5
	5/8 X 1	SA6
	3/4 X 1	SA7
	1 X 1	SA9
	1/8 X 1/2	SA11
	3/16 X 5/8	SA14
	3/4 X 3/4	SA16
	3/16 X 5/8	SA81

<b>CYLINDRICAL END CUT</b>	1/4 X 5/8	SB1
	5/16 X 3/4	SB2
	3/8 X 3/4	SB3
	7/16 X 1	SB4
	1/2 X 1	SB5
	5/8 X 1	SB6
	3/4 X 1	SB7
	1 X 1	SB9
	1/8 X 1/2	SB11
	1/8 X 1	SB12
	3/16 X 5/8	SB14
	3/4 X 3/4	SB16

<b>CYLINDRICAL RADIUS END</b>  	1/4 X 5/8	SA1
	5/16 X 3/4	SA2
	3/8 X 3/4	SA3
	7/16 X 1	SA4
	1/2 X 1	SA5
	5/8 X 1	SA6
	3/4 X 1	SA7
	1 X 1	SA9
	1/8 X 1/2	SA11
	3/16 X 5/8	SA14

<b>BALL END</b>  	1/4	SD1
	5/16	SD2
	3/8	SD3
	7/16	SD4
	1/2	SD5
	5/8	SD6
	3/4	SD7
	1.00	SD9
	1/8	SD11
	3/16	SD14

UNLIMITED SUPPLIES

# CARBIDE BURRS ( CONTINUED)

	DIAMETER X FLUTE	PART NO.
<b>FLAME</b> 	1/4 X 5/8	SH1
	5/16 X 3/4	SH2
	1/2 X 1 1/4	SH5
	5/8 X 1 1/2	SH6
	3/4 X 1 5/8	SH7

	DIAMETER X FLUTE	PART NO.
<b>FLAT RADIUS END 14° TAPER</b> 	1/4 X 5/8	SL1
	5/16 X 7/8	SL2
	3/8 X 1 1/16	SL3
	1/2 X 1 1/8	SL4
	5/8 X 1 5/16	SL6
	3/4 X 1 1/2	SL7

	DIAMETER X FLUTE	PART NO.
<b>EGG</b> 	1/4 X 3/8	SE1
	3/8 X 5/8	SE3
	1/2 X 7/8	SE5
	5/8 X 1	SE6
	3/4 X 1	SE7
	3/16 X 5/8	SE14

<b>CONE POINTED END</b>	1/4 X 1/2	SM1
	1/4 X 3/4	SM2
	1/4 X 1	SM3
	3/8 X 5/8	SM4
	1/2 X 7/8	SM5
	5/8 X 1	SM6

<b>TREE RADIUS END</b>	1/4 X 5/8	SF1
	3/8 X 3/4	SF3
	1/2 X 1	SF5
	5/8 X 1	SF6
	3/4 X 1	SF7
	1/2 X 3/4	SF13
	3/4 X 1 1/4	SF14
	3/4 X 1 1/2	SF15

<b>60° TAPER</b>	1/4	SJ1
	3/8	SJ3
	1/2	SJ5
	5/8	SJ6
	3/4	SJ7
	1.00	SJ9

<b>TREE POINTED END</b> 	1/4 X 5/8	SG1
	5/16 X 3/4	SG2
	3/8 X 3/4	SG3
	1/2 X 1	SG5
	5/8 X 1	SG6
	3/4 X 1	SG7
	1/2 X 3/4	SG13
	3/4 X 1 1/2	SG15

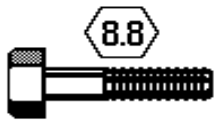

## METRIC HEX CAP SCREWS GRADE 8.8 & 10.9



### M6 X 1.00

Length	Qty.	Grade 8.8	Grade 10.9
12	100	M6C12HH8	M6C12HH10
16	100	M6C16HH8	M6C16HH10
20	100	M6C20HH8	M6C20HH10
25	100	M6C25HH8	M6C25HH10
30	100	M6C30HH8	M6C30HH10
35	100	M6C35HH8	M6C35HH10
40	100	M6C40HH8	M6C40HH10
45	100	M6C45HH8	M6C45HH10
50	100	M6C50HH8	M6C50HH10
55	100	M6C55HH8	M6C55HH10
60	100	M6C60HH8	M6C60HH10

### M8 X 1.25

Length	Qty.	Grade 8.8	Grade 10.9
16	100	M8C16HH8	M8C16HH10
20	100	M8C20HH8	M8C20HH10
25	100	M8C25HH8	M8C25HH10
30	100	M8C25HH8	M8C30HH10
35	100	M8C35HH8	M8C35HH10
40	100	M8C40HH8	M8C40HH10
45	100	M8C45HH8	M8C45HH10
50	100	M8C45HH8	M8C50HH10
55	100	M8C55HH8	M8C55HH10
60	100	M8C60HH8	M8C60HH10
65	100	M8C65HH8	M8C65HH10
100	5	M8C65HH8	M8C100HH10

### M10 X 1.50

Length	Qty.	Grade 8.8	Grade 10.9
16	100	M10C16HH8	M10C16HH10
20	100	M10C20HH8	M10C20HH10
25	100	M10C25HH8	M10C25HH10
30	100	M10C30HH8	M10C30HH10
35	100	M10C35HH8	M10C35HH10
40	100	M10C40HH8	M10C40HH10
45	100	M10C45HH8	M10C45HH10
50	100	M10C50HH8	M10C50HH10
55	50	M10C55HH8	M10C55HH10
60	50	M10C60HH8	M10C60HH10
65	50	M10C65HH8	M10C65HH10
70	50	M10C70HH8	M10C70HH10
75	50	M10C75HH8	M10C75HH10

### M12 X 1.75

Length	Qty.	Grade 8.8	Grade 10.9
20	50	M12C20HH8	M12C20HH10
25	50	M12C25HH8	M12C25HH10
30	50	M12C30HH8	M12C30HH10
35	50	M12C35HH8	M12C35HH10
40	50	M12C40HH8	M12C40HH10
45	50	M12C45HH8	M12C45HH10
50	50	M12C50HH8	M12C50HH10
55	50	M12C55HH8	M12C55HH10
60	50	M12C60HH8	M12C60HH10
65	50	M12C65HH8	M12C65HH10
70	50	M12C70HH8	M12C70HH10
80	25	M12C80HH8	M12C80HH10
90	25	M12C90HH8	M12C90HH10
100	25	M12C100HH8	M12C100HH10

### M16 X 2.00

Length	Qty.	Grade 8.8	Grade 10.9
25	25	M16C25HH8	M16C25HH10
30	25	M16C30HH8	M16C30HH10
35	25	M16C35HH8	M16C35HH10
40	25	M16C40HH8	M16C40HH10
45	25	M16C45HH8	M16C45HH10
50	25	M16C50HH8	M16C50HH10
55	25	M16C55HH8	M16C55HH10
60	25	M16C60HH8	M16C60HH10
65	25	M16C65HH8	M16C65HH10
70	25	M16C70HH8	M16C70HH10
75	25	M16C75HH8	M16C75HH10
80	25	M16C80HH8	M16C80HH10
90	25	M16C90HH8	M16C90HH10
100	25	M16C100HH8	M16C100HH10
110	25	M16C110HH8	M16C110HH10

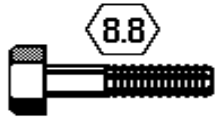

## METRIC HEX CAP SCREWS GRADE 8.8 & 10.9



### M20 X 2.50

Length	Qty.	Grade 8.8	Grade 10.9
35	20	M20C35HH8	M20C35HH10
40	20	M20C40HH8	M20C40HH10
45	20	M20C45HH8	M20C45HH10
50	20	M20C50HH8	M20C50HH10
55	20	M20C55HH8	M20C55HH10
60	20	M20C60HH8	M20C60HH10
65	20	M20C65HH8	M20C65HH10
70	20	M20C70HH8	M20C70HH10
75	20	M20C75HH8	M20C75HH10
80	20	M20C80HH8	M20C80HH10
90	20	M20C90HH8	M20C90HH10
100	20	M20C100HH8	M20C100HH10
110	20	M20C110HH8	M20C110HH10
120	20	M20C120HH8	M20C120HH10
130	20	M20C130HH8	M20C130HH10
140	20	M20C140HH8	M20C140HH10
150	20	M20C150HH8	M20C150HH10

### M24 X 3.00

Length	Qty.	Grade 8.8	Grade 10.9
40	10	M24C40HH8	M24C40HH10
45	10	M24C45HH8	M24C45HH10
50	10	M24C50HH8	M24C50HH10
55	10	M24C55HH8	M24C55HH10
60	10	M24C60HH8	M24C60HH10
65	10	M24C65HH8	M24C65HH10
70	10	M24C70HH8	M24C70HH10
75	10	M24C75HH8	M24C75HH10
80	10	M24C80HH8	M24C80HH10
90	10	M24C90HH8	M24C90HH10
100	10	M24C100HH8	M24C100HH10
110	10	M24C110HH8	M24C110HH10
120	10	M24C120HH8	M24C120HH10
130	10	M24C130HH8	M24C130HH10
140	10	M24C140HH8	M24C140HH10
150	10	M24C150HH8	M24C150HH10

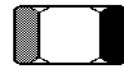

### HEX NUTS GRADE 8.8 & 10.9

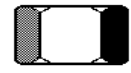

Size	Pkg Qty	Grade 8.8	Grade 10.9
M6	100	M6CHN8	M6CHN10
M8	100	M8CHN8	M8CHN10
M10	100	M10CHN8	M10CHN10
M12	50	M12CHN8	M12CHN10
M16	25	M16CHN8	M16CHN10
M20	20	M20CHN8	M20CHN10
M24	10	M24CHN8	M24CHN10



### LOCK NUTS GRADE 8.8 & 10.9



Size	Pkg Qty	Grade 8.8	Grade 10.9
M6	100	M6CLN8	M6CLN10
M8	100	M8CLN8	M8CLN10
M10	100	M10CLN8	M10CLN10
M12	50	M12CLN8	M12CLN10
M16	25	M16CLN8	M16CLN10
M20	20	M20CLN8	M20CLN10
M24	10	M24CLN8	M24CLN10



### NYLON INSERT LOCKNUTS GRADE 8.8 & 10.9



Size	Pkg Qty	Grade 8.8	Grade 10.9
M6	100	M6CNI8	M6CNI10
M8	100	M8CNI8	M8CNI10
M10	100	M10CNI8	M10CNI10
M12	50	M12CNI8	M12CNI10
M16	25	M16CNI8	M16CNI10
M20	20	M20CNI8	M20CNI10
M24	10	M24CNI8	M24CNI10

We are UNLIMITED Supplies  
Any fastener you can imagine is available  
or Standard

[www.unlimited-usa.com](http://www.unlimited-usa.com)

763-746-5150

UNLIMITED SUPPLIES





**METRIC WASHERS  
GRADE 8.8 & 10.9**



**FLAT WASHERS**



Size	Pkg Qty	Grade 8.8	Grade 10.9
M6	100	M6FW8	M6FW10
M8	100	M8FW8	M8FW10
M10	100	M10FW8	M10FW10
M12	100	M12FW8	M12FW10
M16	50	M16FW8	M16FW10
M20	25	M20FW8	M20FW10
M24	25	M24FW8	M24FW10



**LOCK WASHERS**







Size	Pkg Qty	Grade 8.8	Grade 10.9
M6	100	M6LW8	M6LW10
M8	100	M8LW8	M8LW10
M10	100	M10LW8	M10LW10
M12	100	M12LW8	M12LW10
M16	100	M16LW8	M16LW10
M20	100	M20LW8	M20LW10
M24	100	M24LW8	M24LW10

**METRIC SIZES LISTED ARE STANDARD**

**ALL OTHER SIZES AVAILABLE UPON REQUEST**

# BOLT TORQUE CHART

SIZE	 SAE GRADE 2		 SAE GRADE 5		 SAE GRADE 8		 L9
	ASSEMBLY TORQUE DRY	LUBRICATED	ASSEMBLY TORQUE DRY	LUBRICATED	ASSEMBLY TORQUE DRY	LUBRICATED	ASSEMBLY TORQUE LUBRICATED
1/4-20	66*	49*	8	75*	12	9	11
1/4-28	76*	56*	10	86*	14	10	13
5/16-18	11	8	17	13	20	18	21
5/16-24	12	9	19	14	25	20	23
3/8-16	20	15	30	23	45	30	33
3/8-24	23	17	35	25	50	35	38
7/16-14	30	24	50	35	70	55	60
7/16-20	35	25	55	40	80	60	65
1/2-13	50	35	75	55	110	80	95
1/2-20	55	40	90	65	120	90	105
9/16-12	65	50	110	80	150	110	140
9/16-18	75	55	120	90	170	130	150
5/8-11	90	70	150	110	220	170	185
5/8-18	100	80	180	130	240	180	205
3/4-10	160	120	260	200	380	280	290
3/4-16	180	140	300	220	420	320	355
7/8-9	190	140	400	300	600	460	505
7/8-14	210	155	440	320	660	500	585
1-8	220	160	580	440	900	680	775
1-14	240	170	640	480	1000	740	900
1 1/8-7	300	220	800	600	1280	960	1150
1 1/8-12	340	260	880	660	1440	1080	1325
1 1/4-7	420	320	1120	840	1820	1360	1600
1 1/4-12	460	360	1240	920	2000	1500	1750
1 3/8-6	560	420	1460	1100	2380	1780	-----
1 3/8-12	640	460	1680	1260	2720	2040	-----
1 1/2-6	740	560	1940	1460	3160	2360	3250
1 1/2-12	840	620	2200	1640	3560	2660	3650

ITEMS WITH \* = INCH POUNDS  
ALL OTHERS = FOOT POUNDS

"LUBRICATED"  
INCLUDES LUBRICANTS, LUBRIZING, PLATING, AND HARDENED WASHERS

UNLIMITED SUPPLIES